

HITACHI INVERTER

L700 SERIES

Quick Reference Guide

Read through this Instruction Manual, and keep it handy for future reference.

NT2211X

HITACHI

Introduction

Thank you for purchasing the Hitachi L700 Series Inverter. This Quick Reference guide describes how to handle and maintain the Hitachi L700 Series Inverter. Read this Instruction Manual carefully before using the inverter, and then keep it handy for those who operate, maintain, and inspect the inverter. Before and during the installation, operation and inspection of the inverter, always refer to this Instruction Manual to obtain the necessary related knowledge, and ensure you understand and follow all safety information, precautions, and operating and handling instructions for the correct use of the inverter. Always use the inverter strictly within the range of the specifications described in this Quick Reference guide and correctly implement maintenance and inspections to prevent faults occurring. When using the inverter together with optional products, also read the manuals for those products.

In the manual that relates to this inverter, there are another of this Quick Reference guide and "L700 series Instruction Manual". Please read when you want to hear of a more detailed content about this inverter. It is not described in Quick Reference guide, and a detailed content can be confirmed.

Note that this Quick Reference guide and the manual for each optional product to be used should be delivered to the end user of the inverter.

Handling of this Instruction Manual

- The contents of this Instruction Manual are subject to change without prior notice.
- Even if you lose this Instruction Manual, it will not be resupplied, so please keep it carefully.
- No part of this Instruction Manual may be reproduced in any form without the publisher's permission.
- If you find any incorrect description, missing description or have a question concerning the contents of this Instruction Manual, please contact the publisher.

Revision History

No.	Revision content	Date of issue	Manual code
1	First edition	July,2010	NT2211X

- The current edition of this Instruction Manual also includes some corrections of simple misprints, missing letters, misdescriptions and certain added explanations other than those listed in the above Revision History table.

Safety Instructions

Be sure to read this Instruction Manual and appended documents thoroughly before installing, operating, maintaining, or inspecting the inverter.

In this Instruction Manual, safety instructions are classified into two levels, namely WARNING and CAUTION.

 **WARNING** : Indicates that incorrect handling may cause hazardous situations, which may result in serious personal injury or death.

 **CAUTION** : Indicates that incorrect handling may cause hazardous situations, which may result in moderate or slight personal injury or physical damage alone.

Note that even a  **CAUTION** level situation may lead to a serious consequence according to circumstances. Be sure to follow every safety instruction, which contains important safety information. Also focus on and observe the items and instructions described under "Notes" in the text.

CAUTION

Many of the drawings in this Instruction Manual show the inverter with covers and/or parts blocking your view being removed. Do not operate the inverter in the status shown in those drawings. If you have removed the covers and/or parts, be sure to reinstall them in their original positions before starting operation, and follow all instructions in this Instruction Manual when operating the inverter.

1. Installation

CAUTION

- Install the inverter on a non-flammable surface, e.g., metal. Otherwise, you run the risk of fire.
- Do not place flammable materials near the installed inverter. Otherwise, you run the risk of fire.
- When carrying the inverter, do not hold its top cover. Otherwise, you run the risk of injury by dropping the inverter.
- Prevent foreign matter (e.g., cut pieces of wire, sputtering welding materials, iron chips, wire, and dust) from entering the inverter. Otherwise, you run the risk of fire.
- Install the inverter on a structure able to bear the weight specified in this Instruction Manual. Otherwise, you run the risk of injury due to the inverter falling.
- Install the inverter on a vertical wall that is free of vibrations. Otherwise, you run the risk of injury due to the inverter falling.
- Do not install and operate the inverter if it is damaged or its parts are missing. Otherwise, you run the risk of injury.
- Install the inverter in a well-ventilated indoor site not exposed to direct sunlight. Avoid places where the inverter is exposed to high temperature, high humidity, condensation, dust, explosive gases, corrosive gases, flammable gases, grinding fluid mist, or salt water. Otherwise, you run the risk of fire.
- The inverter is precision equipment. Do not allow it to fall or be subject to high impacts, step on it, or place a heavy load on it. Doing so may cause the inverter to fail.

2. Wiring

WARNING

- Be sure to ground the inverter. Otherwise, you run the risk of electric shock or fire.
- Commit wiring work to a qualified electrician. Otherwise, you run the risk of electric shock or fire.
- Before wiring, make sure that the power supply is off. Otherwise, you run the risk of electric shock or fire.
- Perform wiring only after installing the inverter. Otherwise, you run the risk of electric shock or injury.
- Do not remove rubber bushings from the wiring section. Otherwise, the edges of the wiring cover may damage the wire, resulting in a short circuit or ground fault.

CAUTION

- Make sure that the voltage of AC power supply matches the rated voltage of your inverter. Otherwise, you run the risk of injury or fire.
- Do not input single-phase power into the inverter. Otherwise, you run the risk of fire.
- Do not connect AC power supply to any of the output terminals (U, V, and W). Otherwise, you run the risk of injury or fire.
- Do not connect a resistor directly to any of the DC terminals (PD, P, and N). Otherwise, you run the risk of fire.
- Connect an earth-leakage breaker to the power input circuit. Otherwise, you run the risk of fire.
- Use only the power cables, earth-leakage breaker, and magnetic contactors that have the specified capacity (ratings). Otherwise, you run the risk of fire.
- Do not use the magnetic contactor installed on the primary and secondary sides of the inverter to stop its operation.
- Tighten each screw to the specified torque. No screws must be left loose. Otherwise, you run the risk of fire.
- Before operating, slide switch SW1 in the inverter, be sure to turn off the power supply. Otherwise, you run the risk of electric shock and injury.
- Since the inverter supports two modes of cooling-fan operation, the inverter power is not always off, even when the cooling fan is stopped. Therefore, be sure to confirm that the power supply is off before wiring. Otherwise, you run the risk of electric shock and injury.

Safety Instructions

3. Operation

WARNING

- While power is supplied to the inverter, do not touch any terminal or internal part of the inverter, check signals, or connect or disconnect any wire or connector. Otherwise, you run the risk of electric shock or fire.
- Be sure to close the terminal block cover before turning on the inverter power. Do not open the terminal block cover while power is being supplied to the inverter or voltage remains inside. Otherwise, you run the risk of electric shock.
- Do not operate switches with wet hands. Otherwise, you run the risk of electric shock.
- While power is supplied to the inverter, do not touch the terminal of the inverter, even if it has stopped. Otherwise, you run the risk of injury or fire.
- If the retry mode has been selected, the inverter will restart suddenly after a break in the tripping status. Stay away from the machine controlled by the inverter when the inverter is under such circumstances. (Design the machine so that human safety can be ensured, even when the inverter restarts suddenly.) Otherwise, you run the risk of injury.
- Do not select the retry mode for controlling an elevating or traveling device because output free-running status occurs in retry mode. Otherwise, you run the risk of injury or damage to the machine controlled by the inverter.
- If an operation command has been input to the inverter before a short-term power failure, the inverter may restart operation after the power recovery. If such a restart may put persons in danger, design a control circuit that disables the inverter from restarting after power recovery. Otherwise, you run the risk of injury.
- The [STOP] key is effective only when its function is enabled by setting. Prepare an emergency stop switch separately. Otherwise, you run the risk of injury.
- If an operation command has been input to the inverter before the inverter enters alarm status, the inverter will restart suddenly when the alarm status is reset. Before resetting the alarm status, make sure that no operation command has been input.
- While power is supplied to the inverter, do not touch any internal part of the inverter or insert a bar in it. Otherwise, you run the risk of electric shock or fire.

CAUTION

- Do not touch the heat sink, which heats up during the inverter operation. Otherwise, you run the risk of burn injury.
- The inverter allows you to easily control the speed of motor or machine operations. Before operating the inverter, confirm the capacity and ratings of the motor or machine controlled by the inverter. Otherwise, you run the risk of injury.
- Install an external brake system if needed. Otherwise, you run the risk of injury.
- When using the inverter to operate a standard motor at a frequency of over 60 Hz, check the allowable motor speeds with the manufacturers of the motor and the machine to be driven and obtain their consent before starting inverter operation. Otherwise, you run the risk of damage to the motor and machine.
- During inverter operation, check the motor for the direction of rotation, abnormal sound, and vibrations. Otherwise, you run the risk of damage to the machine driven by the motor.

4. Maintenance, inspection, and parts replacement

WARNING

- Before inspecting the inverter, be sure to turn off the power supply and wait for 10 minutes or more. Otherwise, you run the risk of electric shock.
(Before inspection, confirm that the Charge lamp on the inverter is off and the DC voltage between terminals P and N is 45 V or less.)
- Commit only a designated person to maintenance, inspection, and the replacement of parts.
(Be sure to remove wristwatches and metal accessories, e.g., bracelets, before maintenance and inspection work and to use insulated tools for the work.)
Otherwise, you run the risk of electric shock and injury.

5. Others

WARNING

- Never modify the inverter. Otherwise, you run the risk of electric shock and injury.

CAUTION

- Do not discard the inverter with household waste. Contact an industrial waste management company in your area who can treat industrial waste without polluting the environment.

Precautions Concerning Electromagnetic Compatibility (EMC)

The L700 series inverter conforms to the requirements of Electromagnetic Compatibility (EMC) Directive (2004/108/EC). However, when using the inverter in Europe, you must comply with the following specifications and requirements to meet the EMC Directive and other standards in Europe:

 **WARNING:** This equipment must be installed, adjusted, and maintained by qualified engineers who have expert knowledge of electric work, inverter operation, and the hazardous circumstances that can occur. Otherwise, personal injury may result.

1. Power supply requirements
 - a. Voltage fluctuation must be -15% to +10% or less.
 - b. Voltage imbalance must be $\pm 3\%$ or less.
 - c. Frequency variation must be $\pm 4\%$ or less.
 - d. Total harmonic distortion (THD) of voltage must be $\pm 10\%$ or less.
2. Installation requirement
 - a. A special filter intended for the L700 series inverter must be installed.
3. Wiring requirements
 - a. A shielded wire (screened cable) must be used for motor wiring, and the length of the cable must be according to the following table (Table 1).
 - b. The carrier frequency must be set according to the following table to meet an EMC requirement (Table 1).
 - c. The main circuit wiring must be separated from the control circuit wiring.
4. Environmental requirements (to be met when a filter is used)
 - a. Ambient temperature must be within the range -10°C to $+40^{\circ}\text{C}$.
 - b. Relative humidity must be within the range 20% to 90% (non-condensing).
 - c. Vibrations must be 5.9 m/s^2 (0.6 G) (10 to 55 Hz) or less. (11 to 30kW)
 2.94 m/s^2 (0.3 G) (10 to 55Hz) or less. (37 to 160kW)
 - d. The inverter must be installed indoors (not exposed to corrosive gases and dust) at an altitude of 1,000 m or less.

model	cat.	cable length(m)	carrier frequency(kHz)	model	cat.	cable length(m)	carrier frequency(kHz)
L700-110L	C3	1	1	L700-110H	C3	1	2.5
L700-150L	C3	1	1	L700-150H	C3	1	2.5
L700-185L	C3	1	1	L700-185H	C3	1	2.5
L700-220L	C3	1	1	L700-220H	C3	1	2.5
L700-300L	C3	5	2.5	L700-300H	C3	1	2.5
L700-370L	C3	5	2.5	L700-370H	C3	1	2.5
L700-450L	C3	5	2.5	L700-450H	C3	1	2.5
L700-550L	C3	20	3	L700-550H	C3	5	2.5
L700-750L	C3	20	3	L700-750H	C3	5	2.5
				L700-900H	C3	10	2.5
				L700-110H	C3	10	2.5
				L700-1320H	C3	10	2.5
				L700-1600H	C3	10	2.5

Table 1

Safety Instructions

Precautions Concerning Compliance with UL and cUL Standards

(Standards to be met: UL508C and CSA C22.2 No. 14-05)

These devices are open type and/or Enclosed Type 1 (when employing accessory Type 1 Chassis Kit) AC Inverters with three phase input and three phase output. They are intended to be used in an enclosure. They are used to provide both an adjustable voltage and adjustable frequency to the ac motor. The inverter automatically maintains the required volts-Hz ration allowing the capability through the motor speed range.

1. "Use 60/75 C CU wire only" or equivalent. For models L700 series except for L700-110H and L700-150H.
2. "Use 75C CU wire only" or equivalent. For models L700-110H and L700-150H.
3. "Suitable for use on a circuit capable of delivering not more than 100 k rms symmetrical amperes, 240 V maximum". For models with suffix L.
4. "Suitable for use on a circuit capable of delivering not more than 100 k rms symmetrical amperes, 480 V maximum". For models with suffix H.
5. "Install device in pollution degree 2 environment".
6. "Maximum Surrounding Air Temperature 45 or 50°C".
7. "CAUTION- Risk of Electric Shock- Capacitor discharge time is at least 10 min."
8. "Integral solid state short circuit protection does not provide branch circuit protection. Branch circuit protection must be provided in accordance with the NEC and any additional local codes."
9. "Solid state motor overload protection is provided in each model"
10. Tightening torque and wire range for field wiring terminals are in the table below:

<u>Model No.</u>	<u>Required torque (N-m)</u>	<u>Wire range (AWG)</u>
L700-110L	4.0	6
L700-150L	4.0	6-4
L700-185L	4.9	2
L700-220L	4.9	1
L700-300L	8.8	1 or 1/0
L700-370L	8.8	2/0 or Parallel of 1/0
L700-450L	20.0	4/0 (Prepared wire only) or Parallel of 1/0
L700-550L	20.0	4/0 (Prepared wire only) or Parallel of 1/0
L700-750L	19.6	350 kcmil (Prepared wire only) or Parallel of 2/0 (Prepared wire only)

<u>Model No.</u>	<u>Required Torque (N.m)</u>	<u>Wire Range (AWG)</u>
L700-110H	4.0	10
L700-150H	4.0	8
L700-185H	4.9	6
L700-220H	4.9	6
L700-300H	4.9	6 or 4
L700-370H	4.9	3
L700-450H	20.0	1
L700-550H	20.0	1
L700-750H	20.0	2/0
L700-900H	20.0	Parallel of 1/0
L700-1100H	20.0	Parallel of 1/0
L700-1320H	35.0	Parallel of 3/0
L700-1600H	35.0	Parallel of 3/0

11. Distribution fuse / circuit breaker size marking is included in the manual to indicate that the unit shall be connected with a Listed inverse time circuit breaker, rated 600 V with the current ratings as shown in the table below:

Model No.	Fuse Size (Maximum A)		Circuit Breaker (Maximum A)	
	Type	Rating	Type	Rating
L700-110L	J	60 A	Inverse time	60 A
L700-150L	J	100 A	Inverse time	100 A
L700-185L	J	100 A	Inverse time	100 A
L700-220L	J	100 A	Inverse time	100 A
L700-300L	J	125 A	Inverse time	125 A
L700-370L	J	175 A	Inverse time	175 A
L700-450L	J	225 A	Inverse time	225 A
L700-550L	J	250 A	Inverse time	250 A
L700-750L	J	300 A	Inverse time	300 A
L700-110H	J	30 A	Inverse time	30 A
L700-150H	J	40 A	Inverse time	40 A
L700-185H	J	50 A	Inverse time	50 A
L700-220H	J	50 A	Inverse time	50 A
L700-300H	J	75 A	Inverse time	75 A
L700-370H	J	80 A	Inverse time	80 A
L700-450H	J	100 A	Inverse time	100 A
L700-550H	J	125 A	Inverse time	125 A
L700-750H	J	150 A	Inverse time	150 A
L700-900H	J	225 A	Inverse time	225 A
L700-1100H	J	225 A	Inverse time	225 A
L700-1320H	J	300 A	Inverse time	300 A
L700-1600H	J	350 A	Inverse time	350 A

12. “Field wiring connection must be made by a UL Listed and CSA Certified ring lug terminal connector sized for the wire gauge being used. The connector must be fixed using the crimping tool specified by the connector manufacturer.”

Contents

Chapter 1 Overview

1.1 Inspection of the Purchased Product	1 - 2
1.1.1 Inspecting the product	1 - 2
1.1.2 Instruction manual (this manual)	1 - 2
1.2 Method of Inquiry and Product Warranty	1 - 3
1.2.1 Method of inquiry	1 - 3
1.2.2 Product warranty	1 - 3
1.2.3 Warranty Terms	1 - 3
1.3 Exterior Views and Names of Parts	1 - 4

Chapter 2 Installation and Wiring

2.1 Installation	2 - 2
2.1.1 Precautions for installation	2 - 3
2.1.2 Backing plate	2 - 5
2.2 Wiring	2 - 6
2.2.1 Terminal connection diagram and explanation of terminals and switch settings	2 - 7
2.2.2 Wiring of the main circuit	2 - 11
2.2.3 Wiring of the control circuit	2 - 18
2.2.4 Wiring of the digital operator	2 - 19
2.2.5 Selection and wiring of regenerative braking resistor (on 11 kW to 30 kW models)	2 - 20

Chapter 3 Operation

3.1 Operating Methods	3 - 2
3.2 How To Operate the Digital Operator	3 - 4
3.2.1 Names and functions of components	3 - 4
3.2.2 Code display system and key operations	3 - 5

Chapter 4 List of Data Settings

4.1 Precautions for Data Setting	4 - 2
4.2 Monitoring Mode	4 - 2
4.3 Function Mode	4 - 3
4.4 Extended Function Mode	4 - 4

Chapter 5 Error Codes

5.1 Error Codes and Troubleshooting	5 - 2
5.1.1	Error codes
5.1.2	Trip conditions monitoring
5.2 Warning Codes	5 - 5

Chapter 6 Specifications

6.1 Specifications	6 - 2
6.2 External dimensions	6 - 5

Chapter 1 Overview

This chapter describes the inspection of the purchased product, the product warranty, and the names of parts.

- 1.1 Inspection of the Purchased Product 1 - 2
- 1.2 Method of Inquiry and Product Warranty 1 - 3
- 1.3 Exterior Views and Names of Parts 1 - 4

Chapter 1 Overview

1.1 Inspection of the Purchased Product

1.1.1 Inspecting the product

After unpacking, inspect the product as described below.

If you find the product to be abnormal or defective, contact your supplier or local Hitachi Distributor.

- (1) Check the product for damage (including falling of parts and dents in the inverter body) caused during transportation.
- (2) Check that the product package contains an inverter set and this Instruction Manual.
- (3) Check the specification label to confirm that the product is the one you ordered.

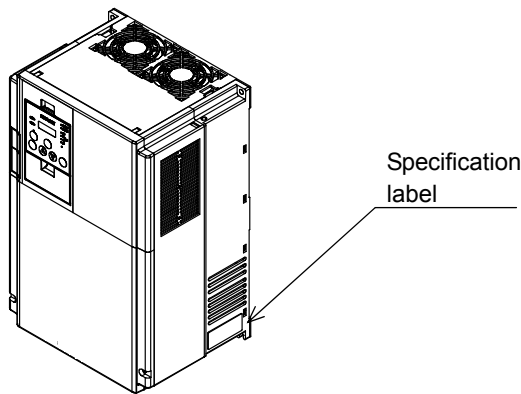

Figure 1-1 Location of the specifications label

	HITACHI	INVERTER
Inverter model →	Model: L700-150HFF	
Input ratings →	Input : 50Hz, 60Hz	V 1Ph A
	50Hz, 60Hz	380 - 480 V 3Ph 32 A
Output ratings →	Output : 0 - 400Hz	380 - 480 V 3Ph 29 A
Serial number →	MFG No. 03AAT12345 A 001	Date:1003
	Hitachi Industrial Equipment Systems Co., Ltd.	MADE IN JAPAN NE18028- 8

Figure 1-2 Contents of the specifications label

1.1.2 Instruction manual (this manual)

This Instruction Manual (Quick Reference Guide) describes how to operate the Hitachi L700 Series Inverter.

Read this Instruction Manual thoroughly before using the inverter, and then keep it handy for future reference.

When using the inverter, together with optional products for the inverter, also refer to the manuals supplied with the optional products.

Note that this Instruction Manual and the manual for each optional product to be used should be delivered to the end user of the inverter.

1.2 Method of Inquiry and Product Warranty

1.2.1 Method of inquiry

For an inquiry about product damage or faults or a question about the product, notify your supplier of the following information:

- (1) Model of your inverter
- (2) Serial number (MFG No.)
- (3) Date of purchase
- (4) Content of inquiry
 - Location and condition of damage
 - Content of your question

1.2.2 Product warranty

The product will be warranted for one year after the date of purchase.

Even within the warranty period, repair of a product fault will not be covered by the warranty (but the repair will be at your own cost) if:

- (1) the fault has resulted from incorrect usage not conforming to the instructions given in this Instruction Manual or the repair or modification of the product carried out by an unqualified person,
- (2) the fault has resulted from a cause not attributable to the delivered product,
- (3) the fault has resulted from use beyond the limits of the product specifications, or
- (4) the fault has resulted from disaster or other unavoidable events.

The warranty will only apply to the delivered inverter and excludes all damage to other equipment and facilities induced by any fault of the inverter.

The warranty is effective only in Japan.

Repair at the user's charge

Following the one-year warranty period, any examination and repair of the product will be accepted at your charge. Even during the warranty period, examination and repairs of faults, subject to the above scope of the warranty disclaimer, will be available at charge.

To request a repair at your charge, contact your supplier or local Hitachi Distributor.

The Hitachi Distributors are listed on the back cover of this Instruction Manual.

1.2.3 Warranty Terms

The warranty period under normal installation and handling conditions shall be two (2) years from the date of manufacture ("DATE" on product nameplate), or one (1) year from the date of installation, whichever occurs first. The warranty shall cover the repair or replacement, at Hitachi's sole discretion, of ONLY the inverter that was installed.

- (1) Service in the following cases, even within the warranty period, shall be charged to the purchaser:
 - a. Malfunction or damage caused by mis-operation or modification or improper repair
 - b. Malfunction or damage caused by a drop after purchase and transportation
 - c. Malfunction or damage caused by fire, earthquake, flood, lightening, abnormal input voltage, contamination, or other natural disasters
- (2) When service is required for the product at your work site, all expenses associated with field repair shall be charged to the purchaser.
- (3) Always keep this manual handy; please do not lose it. Please contact your Hitachi distributor to purchase replacement or additional manuals.

1.3 Exterior Views and Names of Parts

The figure below shows an exterior view of the inverter (model L700-185LFF/HFF to L700-300LFF/HFF).

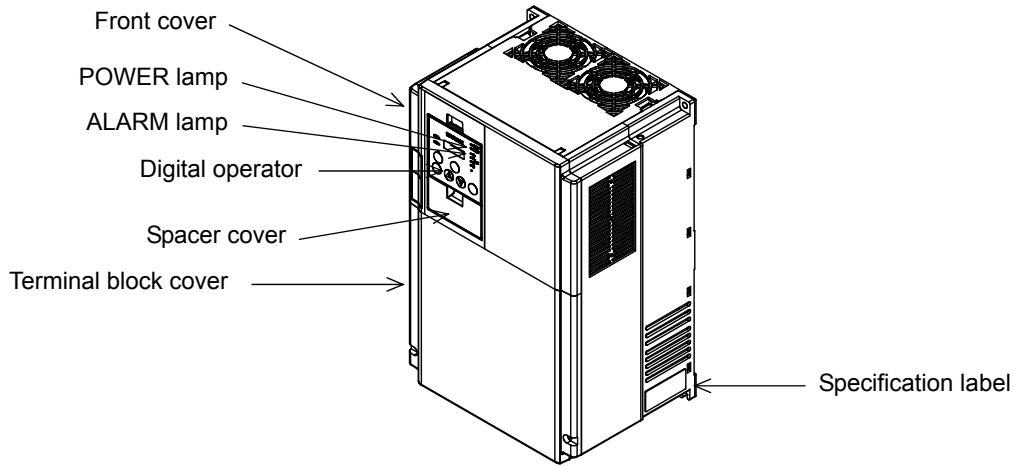

Exterior view of shipped inverter

For the wiring of the main circuit and control circuit terminals, open the terminal block cover.
For mounting optional circuit boards, open the front cover.

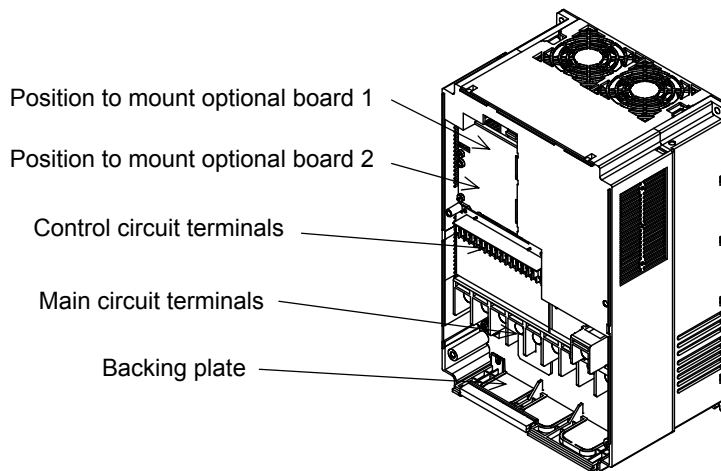

Exterior view of inverter with front and terminal block covers removed

Chapter 2 Installation and Wiring

This chapter describes how to install the inverter and the wiring of main circuit and control signal terminals with typical examples of wiring.

2.1	Installation	2 - 2
2.2	Wiring	2 - 6

2.1 Installation



- Install the inverter on a non-flammable surface, e.g., metal. Otherwise, you run the risk of fire.
- Do not place flammable materials near the installed inverter. Otherwise, you run the risk of fire.
- When carrying the inverter, do not hold its top cover. Otherwise, you run the risk of injury by dropping the inverter.
- Prevent foreign matter (e.g., cut pieces of wire, sputtering welding materials, iron chips, wire, and dust) from entering the inverter. Otherwise, you run the risk of fire.
- Install the inverter on a structure able to bear the weight specified in this Instruction Manual. Otherwise, you run the risk of injury due to the inverter falling.
- Install the inverter on a vertical wall that is free of vibrations. Otherwise, you run the risk of injury due to the inverter falling.
- Do not install and operate the inverter if it is damaged or its parts are missing. Otherwise, you run the risk of injury.
- Install the inverter in a well-ventilated indoor site not exposed to direct sunlight. Avoid places where the inverter is exposed to high temperature, high humidity, condensation, dust, explosive gases, corrosive gases, flammable gases, grinding fluid mist, or salt water. Otherwise, you run the risk of fire.
- The inverter is precision equipment. Do not allow it to fall or be subject to high impacts, step on it, or place a heavy load on it. Doing so may cause the inverter to fail.

2.1.1 Precautions for installation

(1) Transportation

The inverter uses plastic parts. When carrying the inverter, handle it carefully to prevent damage to the parts.

Do not carry the inverter by holding the front or terminal block cover. Doing so may cause the inverter to fall. Do not install and operate the inverter if it is damaged or its parts are missing.

(2) Surface on which to install the inverter

The inverter will reach a high temperature (up to about 150°C) during operation. Install the inverter on a vertical wall surface made of nonflammable material (e.g., metal) to avoid the risk of fire.

Leave sufficient space around the inverter. In particular, keep sufficient distance between the inverter and other heat sources (e.g., braking resistors and reactors) if they are installed in the vicinity.

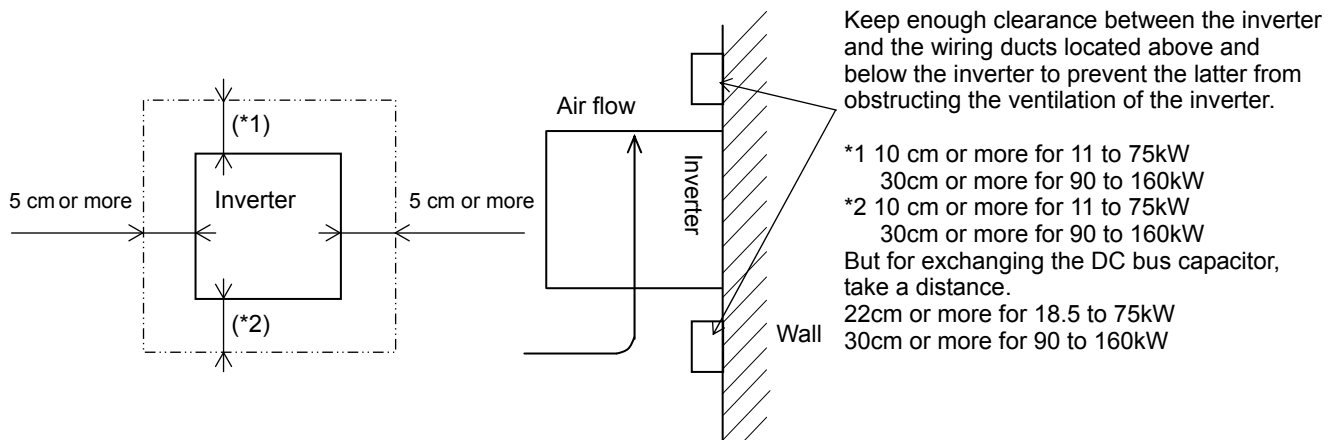

(3) Ambient temperature

Avoid installing the inverter in a place where the ambient temperature goes above or below the allowable range (-10°C to +40°C), as defined by the standard inverter specification.

Measure the temperature in a position about 5 cm distant from the bottom-center point of the inverter, and check that the measured temperature is within the allowable range.

Operating the inverter at a temperature outside this range will shorten the inverter life (especially the capacitor life).

(4) Humidity

Avoid installing the inverter in a place where the relative humidity goes above or below the allowable range (20% to 90% RH), as defined by the standard inverter specification.

Avoid a place where the inverter is subject to condensation.

Condensation inside the inverter will result in short circuits and malfunctioning of electronic parts. Also avoid places where the inverter is exposed to direct sunlight.

(5) Ambient air

Avoid installing the inverter in a place where the inverter is subject to dust, corrosive gases, combustible gases, flammable gases, grinding fluid mist, or salt water.

Foreign particles or dust entering the inverter will cause it to fail. If you use the inverter in a considerably dusty environment, install the inverter inside a totally enclosed panel.

Chapter 2 Installation and Wiring

(6) Installation method and position

Install the inverter vertically and securely with screws or bolts on a surface that is free from vibrations and that can bear the inverter weight.

If the inverter is not installed vertically, its cooling performance may be degraded and tripping or inverter damage may result.

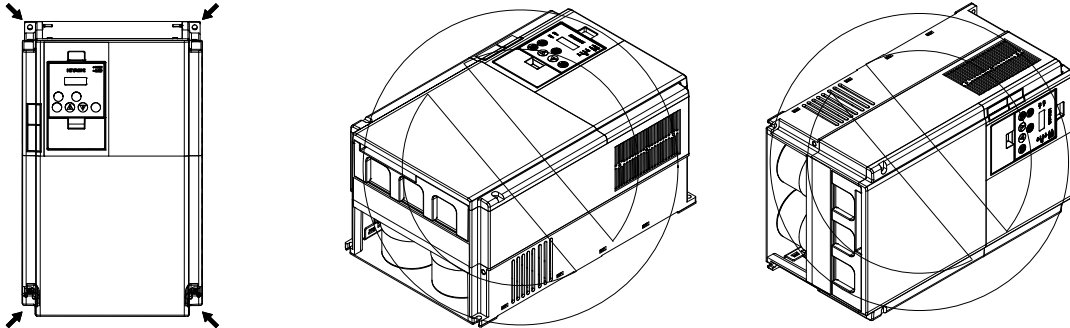

(7) Mounting in an enclosure

Heat in the inverter rises from the under to the upper part of the inverter up with the fan built into the inverter, and make it to the one without the obstacle even if the influence of heat is received, please when you arrange apparatus up.

Moreover, please usually arrange it sideways like the left side of the figure below when you store two or more inverters in the same enclosure.

The temperature in an upper inverter rises because of the heat of a lower inverter when it places one behind another unavoidably to reduce the space of the enclosure, it causes the inverter breakdown, and set it up, please so that the heat of a lower inverter should not influence an upper inverter.

Please note it enough as ventilation, ventilation, and the size of the board are enlarged so that the ambient temperature of the inverter should not exceed the permissible value when two or more inverters are stored on the enclosure.

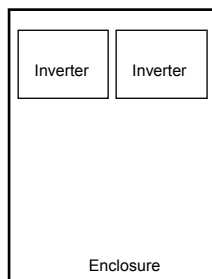

Sideways

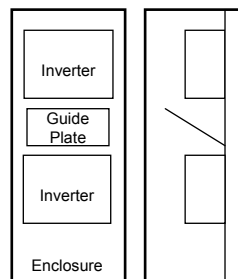

Behind another

(8) When mounting multiple inverters in an enclosure with a ventilation fan, carefully design the layout of the ventilation fan, air intake port, and inverters.

An inappropriate layout will reduce the inverter-cooling effect and raise the ambient temperature. Plan the layout so that the inverter ambient temperature will remain within the allowable range.

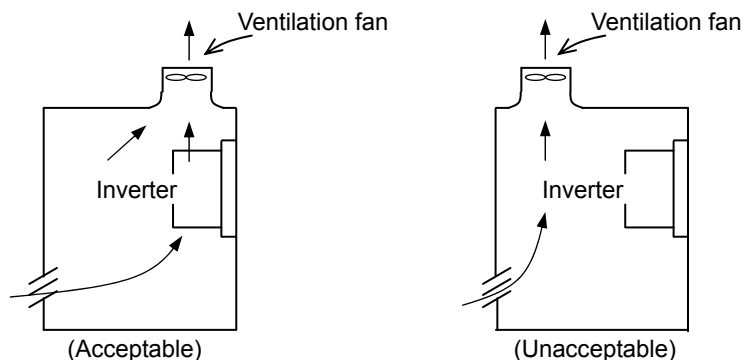

Position of ventilation fan

(9) Reduction of enclosure size

If you mount the inverter inside an enclosure such that the heat sink of the inverter is positioned outside the enclosure, the amount of heat produced inside the enclosure can be reduced and likewise the size of the enclosure.

Mounting the inverter in an enclosure with the heat sink positioned outside requires an optional dedicated special metal fitting.

To mount the inverter in an enclosure with the heat sink positioned outside, cut out the enclosure panel according to the specified cutting dimensions.

The cooling section (including the heat sink) positioned outside the enclosure has a cooling fan.

Therefore, do not place the enclosure in any environment where it is exposed to waterdrops, oil mist, or dust.

(10) Approximate loss by inverter capacity

Inverter capacity (kW)	11	15	18.5	22	30	37	45	55	75	90	110	132	160
Loss with 70% load (W)	435	575	698	820	1100	1345	1625	1975	2675	3375	3900	4670	5660
Loss with 100% load (W)	600	800	975	1150	1550	1900	2300	2800	3800	4800	5550	6650	8060
Efficiency at rated output (%)	94.8	94.9	95.0	95.0	95.0	95.1	95.1	95.1	95.2	95.2	95.2	95.2	95.2

2.1.2 Backing plate

(1) For models with 30 kW or less capacity

On the backing plate, cut the joints around each section to be cut off with cutting pliers or a cutter, remove them, and then perform the wiring.

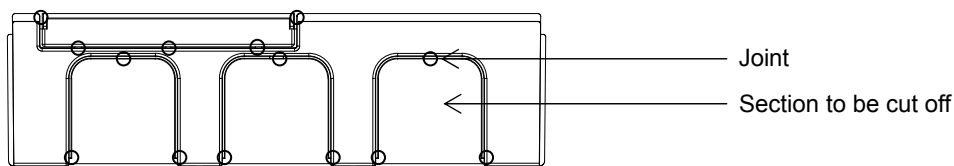

(2) For the models with 37 kW to 75kW

1) For wiring without using conduits

Cut an X in each rubber bushing of the backing plate with cutting pliers or a cutter, and then perform the wiring.

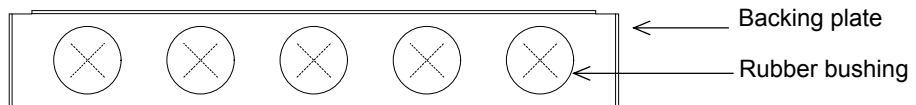

2) For wiring using conduits

Remove the rubber bushings from the holes to be used for wiring with conduits, and then fit conduits into the holes.

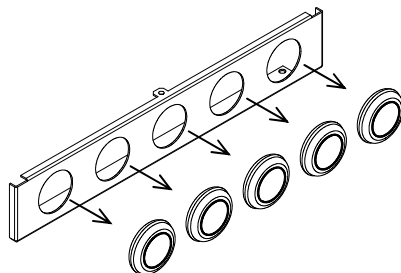

Note: Do not remove the rubber bushing from holes that are not used for wiring with a conduit.

If a cable is connected through the plate hole without a rubber bushing and conduit, the cable insulation may be damaged by the edge of the hole, resulting in a short circuit or ground fault.

2.2 Wiring

WARNING

- Be sure to ground the inverter. Otherwise, you run the risk of electric shock or fire.
- Commit wiring work to a qualified electrician. Otherwise, you run the risk of electric shock or fire.
- Before wiring, make sure that the power supply is off. Otherwise, you run the risk of electric shock or fire.
- Perform wiring only after installing the inverter. Otherwise, you run the risk of electric shock or injury.
- Do not remove rubber bushings from the wiring section. Otherwise, the edges of the wiring cover may damage the wire, resulting in a short circuit or ground fault.

CAUTION

- Make sure that the voltage of AC power supply matches the rated voltage of your inverter. Otherwise, you run the risk of injury or fire.
- Do not input single-phase power into the inverter. Otherwise, you run the risk of fire.
- Do not connect AC power supply to any of the output terminals (U, V, and W). Otherwise, you run the risk of injury or fire.
- Do not connect a resistor directly to any of the DC terminals (PD, P, and N). Otherwise, you run the risk of fire.
- Connect an earth-leakage breaker to the power input circuit. Otherwise, you run the risk of fire.
- Use only the power cables, earth-leakage breaker, and magnetic contactors that have the specified capacity (ratings). Otherwise, you run the risk of fire.
- Do not use the magnetic contactor installed on the primary and secondary sides of the inverter to stop its operation.
- Tighten each screw to the specified torque. No screws must be left loose. Otherwise, you run the risk of fire.
- Before operating, slide switch SW1 in the inverter, be sure to turn off the power supply. Otherwise, you run the risk of electric shock and injury.
- Since the inverter supports two modes of cooling-fan operation, the inverter power is not always off, even when the cooling fan is stopped. Therefore, be sure to confirm that the power supply is off before wiring. Otherwise, you run the risk of electric shock and injury.

2.2.1 Terminal connection diagram and explanation of terminals and switch settings

3-phase power supply

200 V class: 200 to 240 V +10%, -15%
(50/60 Hz ±5%)

400 V class: 380 to 480 V +10%, -15%
(50/60 Hz ±5%)

When connecting separate power supplies to main and control circuits, remove J51 connector cables beforehand. (See page 2-17)

Default jumper position (sinking type inputs)

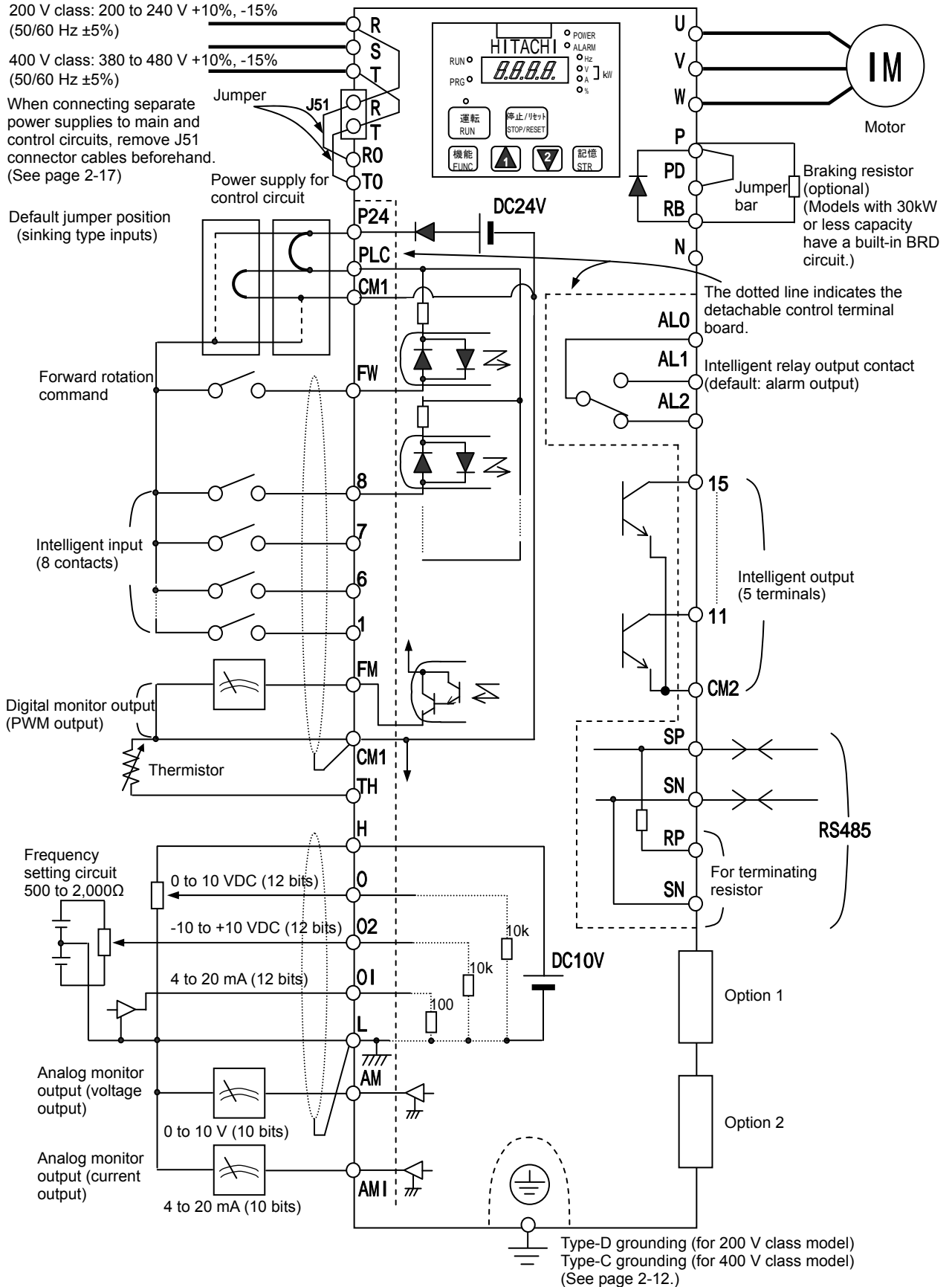

Chapter 2 Installation and Wiring

(1) Explanation of main circuit terminals

Symbol	Terminal name	Description
R, S, T (L1, L2, L3)	Main power input	Connect to the AC power supply. Leave these terminals unconnected when using a regenerative converter (HS900 series).
U, V, W (T1, T2, T3)	Inverter output	Connect a 3-phase motor.
PD, P (+1, +)	DC reactor connection	Remove the jumper from terminals PD and P, and connect the optional power factor reactor (DCL).
P, RB (+, RB)	External braking resistor connection	Connect the optional external braking resistor. (The RB terminal is provided on models with 30 kW or less capacity.)
P, N (+, -)	Regenerative braking unit connection	Connect the optional regenerative braking unit (BRD).
G ⊕	Inverter ground	Connect to ground for grounding the inverter chassis by type-D grounding (for 200 V class models) or type-C grounding (for 400 V class models).

(2) Explanation of control circuit terminals

		Symbol	Terminal name	Description	Electric property	
Analog	Power supply	L	Analog power supply (common)	This common terminal supplies power to frequency command terminals (O, O2, and OI) and analog output terminals (AM and AMI). Do not ground this terminal.		
		H	Frequency setting power supply	This terminal supplies 10 VDC power to the O, O2, OI terminals.	Allowable load current: 20 mA or less	
	Frequency setting input	O	Frequency command (voltage)	Input a voltage (0 to 10 VDC) as a frequency command. 10 V specifies the maximum frequency. To specify the maximum frequency with a voltage of 10 V or less, set the voltage using function "A014".	Input impedance: 10kΩ Allowable input voltages: -0.3 to +12 VDC	
		O2	Auxiliary frequency command (voltage)	Input a voltage (0 to ±10 VDC) as a signal to be added to the frequency command input from the O or OI terminal. You can input an independent frequency command from this terminal (O2 terminal) alone by changing the setting.	Input impedance: 10kΩ Allowable input voltages: 0 to ±12 VDC	
		OI	Frequency command (current)	Input a current (4 to 20 mA DC) as a frequency command. 20 mA specifies the maximum frequency. The OI signal is valid only when the AT signal is on. Assign the AT function to an intelligent input terminal.	Input impedance: 10kΩ Maximum allowable current: 24 mA	
	Monitor output	AM	Analog monitor (voltage)	This terminal outputs one of the selected "0 to 10 VDC voltage output" monitoring items. The monitoring items available for selection include output frequency, output current, output torque (signed or unsigned), output voltage, input power, electronic thermal overload, LAD frequency, motor temperature, heat sink temperature, and general output.	Maximum allowable current: 2 mA	
AMI		Analog monitor (current)	This terminal outputs one of the selected "4 to 20 mA DC current output" monitoring items. The monitoring items available for selection include output frequency, output current, output torque (unsigned), output voltage, input power, electronic thermal overload, LAD frequency, motor temperature, heat sink temperature, and general output.	Allowable load impedance: 250Ω or less		
Digital (contact)	Monitor output	FM	Digital monitor (voltage)	This terminal outputs one of the selected "0 to 10 VDC voltage output (PWM output mode)" monitoring items. The monitoring items available for selection include output frequency, output current, output torque (unsigned), output voltage, input power, electronic thermal overload, LAD frequency, motor temperature, heat sink temperature, general output, digital output frequency, and digital current monitor. For the items "digital output frequency" and "digital current monitor," this terminal outputs a digital pulse signal at 0/10 VDC with a duty ratio of 50%.	Maximum allowable current: 1.2 mA Maximum frequency: 3.6 kHz	
	Power supply	P24	Interface power supply	This terminal supplies 24 VDC power for contact input signals. If the source logic is selected, this terminal is used as a common contact input terminal.	Maximum allowable output current: 100 mA	
		CM1	Interface power supply (common)	This common terminal supplies power to the interface power supply (P24), thermistor input (TH), and digital monitor (FM) terminals. If the sink logic is selected, this terminal is used as a common contact input terminal. Do not ground this terminal.		
	Contact input	Operation command	FW	Forward rotation command	Turn on this FW signal to start the forward rotation of the motor; turn it off to stop forward rotation after deceleration.	[Conditions for turning contact input on] Voltage across input and PLC: 18 VDC or more
		Function selection and logic switching	1 2 3 4 5 6 7 8	Intelligent input	Select eight of a total 60 functions, and assign these eight functions to terminals 1 to 8. Note: If the emergency stop function is used, terminals 1 and 3 are used exclusively for the function. For details, see Item (3), "Emergency stop function" (on page 2-8).	Input impedance between input and PLC: 4.7kΩ Maximum allowable voltage across input and PLC: 27 VDC Load current with 27 VDC power: about 5.6 mA

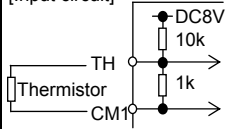
			Symbol	Terminal name	Description	Electric property
Digital (contact)	Contact input	Function selection and logic switching	PLC	Intelligent input (common)	To switch the control logic between sink logic and source logic, change the jumper connection of this (PLC) terminal to another terminal on the control circuit terminal block. Jumper terminals P24 and PLC for the sink logic; jumper terminals CM1 and PLC for the sink logic. To use an external power supply to drive the contact inputs, remove the jumper, and connect the PLC terminal to the external interface circuit.	
	Open collector output	Status and factor	11 12 13 14 15	Intelligent output	Select five of a total 51 functions, and assign these five functions to terminals 11 to 15. If you have selected an alarm code using the function "C062", terminals 11 to 13 or 11 to 14 are used exclusively for the output of cause code for alarm (e.g., inverter trip). The control logic between each of these terminals and the CM2 terminal always follows the sink or source logic.	Voltage drop between each terminal and CM2 when output signal is on: 4 V or less
			CM2	Intelligent output (common)	This terminal serves as the common terminal for intelligent output terminals [11] to [15].	Maximum allowable voltage: 27 VDC Maximum allowable current: 50 mA
	Relay contact output	Status and alarm	AL0 AL1 AL2	Intelligent relay output	Select functions from the 43 available, and assign the selected functions to these terminals, which serve as C contact output terminals. In the initial setting, these terminals output an alarm indicating that the inverter protection function has operated to stop inverter output.	(Maximum contact capacity) AL1-AL0: 250 VAC, 2 A (resistance) or 0.2 A (inductive load) AL2-AL0: 250 VAC, 1 A (resistance) or 0.2 A (inductive load) (Minimum contact capacity) 100 VAC, 10 mA 5 VDC, 100 mA
Analog	Analog input	Sensor	TH	External thermistor input	Connect to an external thermistor to make the inverter trip if an abnormal temperature is detected. The CM1 terminal serves as the common terminal for this terminal. [Recommended thermistor properties] Allowable rated power: 100 mW or more Impedance at temperature error: 3kΩ The impedance to detect temperature errors can be adjusted within the range 0Ω to 9,999Ω.	Allowable range of input voltages 0 to 8 VDC [Input circuit] 

Chapter 2 Installation and Wiring

(3) Explanation of switch

SW1: It is a switch that switches effective and the invalidity of the urgent disconnect function (The state of the factory shipment: this function invalidity).

Please use the urgent invalidity function after perusing "4.4 urgent disconnect function".

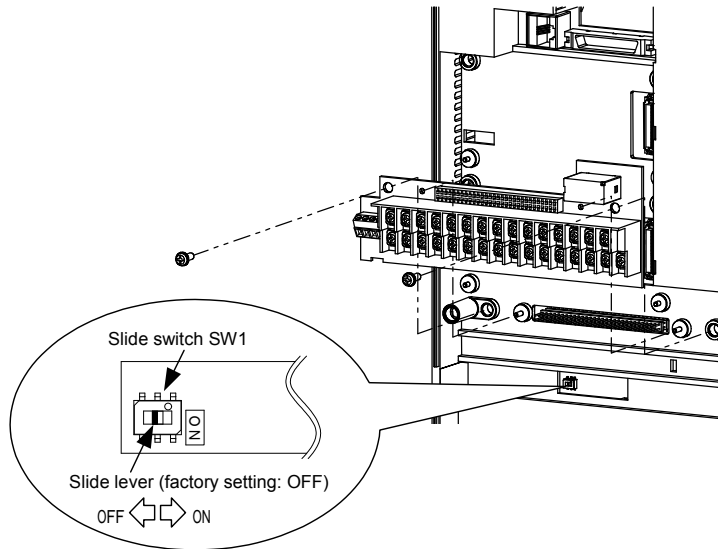

Note: Slide Switch 12

Some models have slide switch in the position as shown below. Default setting of this switch is at "ON" position. Please don't change the setting. If it is changed, inverter may trip and disabled to run.

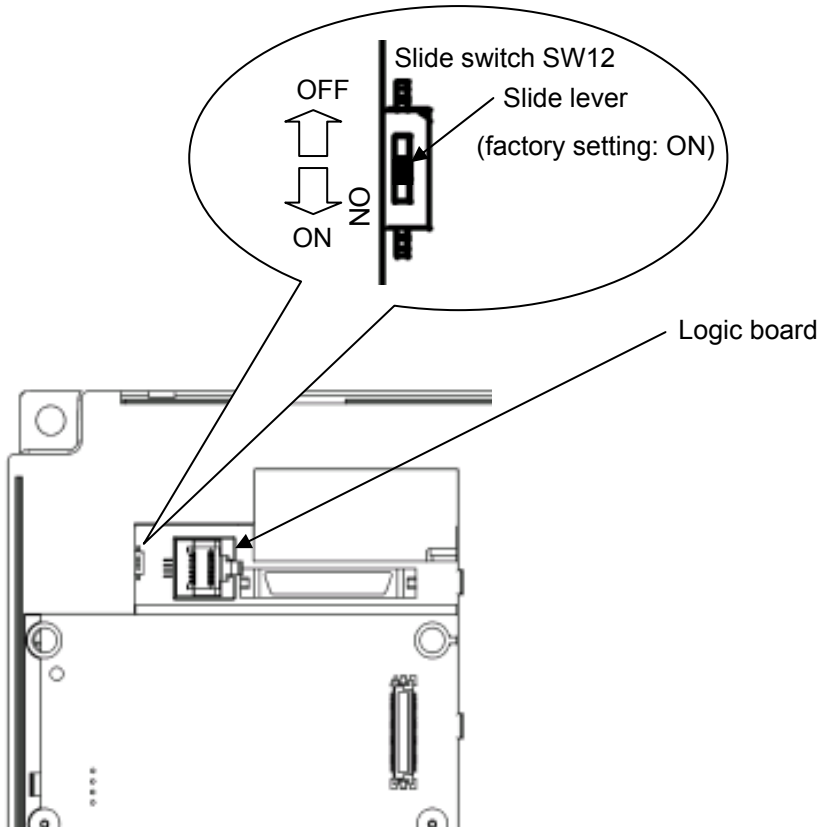

2.2.2 Wiring of the main circuit

(1) Wiring instructions

Before wiring, be sure to confirm that the Charge lamp on the inverter is off.

When the inverter power has been turned on once, a dangerous high voltage remains in the internal capacitors for some time after power-off, regardless of whether the inverter has been operated.

When rewiring after power-off, always wait 10 minutes or more after power-off, and check with a multimeter that the residual voltage across terminals P and N is zero to ensure safety during rewiring work.

1) Main power input terminals (R, S, and T)

- Connect an earth-leakage breaker for circuit (wiring) protection between the power supply and main power input terminals (R, S, and T).
- Use an earth-leakage breaker with a high rating of a high-frequency sensitive current to prevent the breaker from malfunctioning under the influence of high frequency.
- When the protective function of the inverter operates, a fault or accident may occur in your system. Therefore, you are recommended to connect a magnetic contactor that interrupts the power supply to the inverter.
- Do not use the magnetic contactor connected to the power input terminal (primary side) or power output terminal (secondary side) of the inverter to start or stop the inverter.
To start and stop inverter operation by external signals, use only the operation commands (FW and RV signals) that are input via control circuit terminals.
- This inverter does not support a single-phase power supply but supports only a three-phase power supply.
If you need to use a single-phase power input, contact your supplier or local Hitachi Distributor.
- Do not operate the inverter with an phase loss power input, or it may be damaged.
Since the factory setting of the inverter disables the phase loss input protection, the inverter will revert to the following status if a phase of power supply input is interrupted:
R or T phase interrupted: The inverter does not operate.
S phase interrupted: The inverter reverts to single-phase operation, and may trip because of insufficient voltage or overcurrent or be damaged.
Internal capacitors remain charged, even when the power input is under an phase loss condition. Therefore, touching an internal part may result in electric shock and injury.
When rewiring the main circuit, follow the instructions given in Item (1), "Wiring instructions."
- Carefully note that the internal converter module of the inverter may be damaged if:
 - the imbalance of power voltage is 3% or more,
 - the power supply capacity is at least 10 times as high as the inverter capacity and 500 kVA or more, or
 - the power voltage changes rapidly.
- Example: The above conditions may occur when multiple inverters are connected to each other by a short bus line or your system includes a phase-advanced capacitor that is turned on and off during operation.
- Do not turn the inverter power on and off more often than once every 3 minutes.
Otherwise, the inverter may be damaged.

2) Inverter output terminals (U, V, and W)

- Use a cable thicker than the specified applicable cable for the wiring of output terminals to prevent the output voltage between the inverter and motor dropping. Especially at low frequency output, a voltage drop due to cable will cause the motor torque to decrease.
- Do not connect a phase-advanced capacitor or surge absorber on the output side of the inverter. If connected, the inverter may trip or the phase-advanced capacitor or surge absorber may be damaged.
- If the cable length between the inverter and motor exceeds 20 m (especially in the case of 400 V class models), the stray capacitance and inductance of the cable may cause a surge voltage at motor terminals, resulting in a motor burnout.
A special filter to suppress the surge voltage is available. If you need this filter, contact your supplier or local Hitachi Distributor.

Chapter 2 Installation and Wiring

- When connecting multiple motors to the inverter, connect a thermal relay to the inverter output circuit for each motor.
 - The RC rating of the thermal relay must be 1.1 times as high as the rated current of the motor. The thermal relay may go off too early, depending on the cable length. If this occurs, connect an AC reactor to the output of the inverter.
- 3) DC reactor connection terminals (PD and P)
- Use these terminals to connect the optional DC power factor reactor (DCL).
As the factory setting, terminals P and PD are connected by a jumper. Remove this to connect the DCL.
 - The cable length between the inverter and DCL must be 5 m or less.

Remove the jumper only when connecting the DCL.
If the jumper is removed and the DCL is not connected, power is not supplied to the main circuit of the inverter, and the inverter cannot operate.

- 4) External braking resistor connection terminals (P and RB) and regenerative braking unit connection terminals (P and N)
- Inverter models with 30 kW or less capacity have a built-in regenerative braking (BRD) circuit. If you need increased braking performance, connect an optional external braking resistor to terminals P and RB.
Do not connect an external braking resistor with resistance less than the specified value. Such a resistor may cause damage to the regenerative braking (BRD) circuit.
 - Inverter models with capacity of 37 kW or more do not have a built-in regenerative braking (BRD) circuit.
Increasing the braking performance of these models requires an optional regenerative braking unit and an external braking resistor. Connect the P and N terminals of the optional regenerative braking unit to the P and N terminals of the inverters.
 - The cable length between the inverter and optional regenerative braking unit must be 5 m or less, and the two cables must be twisted for wiring.
 - Do not use these terminals for connecting any devices other than the optional external braking resistor and regenerative braking unit.
- 5) Inverter ground terminal (G ⊕)
- Be sure to ground the inverter and motor to prevent electric shock.
 - According to the Electric Apparatus Engineering Regulations, connect 200 V class models to grounding electrodes constructed in compliance with type-D grounding (conventional type-III grounding with ground resistance of 100Ω or less) or the 400 V class models to grounding electrodes constructed in compliance with type-C grounding (conventional special type-III grounding with ground resistance of 10Ω or less).
 - Use a grounding cable thicker than the specified applicable cable, and make the ground wiring as short as possible.
 - When grounding multiple inverters, avoid a multi-drop connection of the grounding route and formation of a ground loop, otherwise the inverter may malfunction.

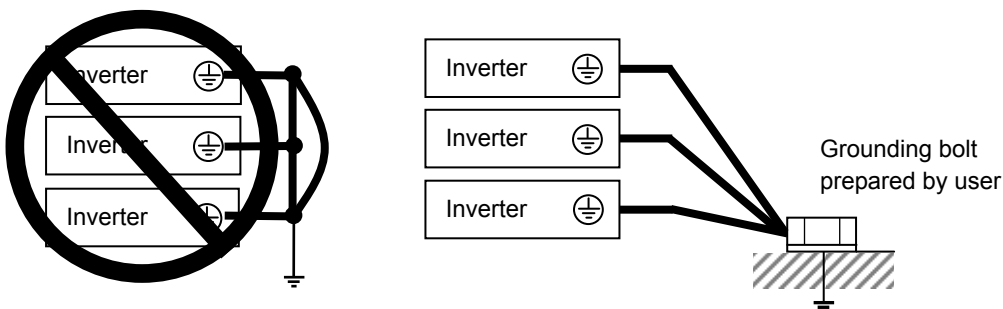

(2) Layout of main circuit terminals

The figures below show the terminal layout on the main circuit terminal block of the inverter.

Terminal layout	Inverter model
<div style="text-align: center;"> </div> <p style="text-align: center;">Ground terminal with jumper (shaded in the figure) to enable/disable the EMC filter function</p> <p style="text-align: center;">When not using the DCL, do not remove the jumper from terminals PD and P.</p> <p>[Method of enabling/disabling the EMC filter function]</p> <div style="display: flex; justify-content: space-around;"> <div style="text-align: center;"> <p>Enabling the EMC filter</p> </div> <div style="text-align: center;"> <p>Disabling the EMC filter (factory setting)</p> </div> </div>	<p>L700-110LFF L700-110HFF</p> <p>R0 and T0: M4 Ground terminal: M5 Other terminals: M5</p>
<div style="text-align: center;"> </div> <p style="text-align: center;">Ground terminal with jumper (shaded in the figure) to enable/disable the EMC filter function</p> <p style="text-align: center;">When not using the DCL, do not remove the jumper from terminals PD and P.</p> <p>[Method of enabling/disabling the EMC filter function]</p> <div style="display: flex; justify-content: space-around;"> <div style="text-align: center;"> <p>Enabling the EMC filter</p> </div> <div style="text-align: center;"> <p>Disabling the EMC filter (factory setting)</p> </div> </div>	<p>L700-150LFF L700-150HFF</p> <p>R0 and T0: M4 Ground terminal: M5 Other terminals: M6</p>
<div style="text-align: center;"> </div> <p style="text-align: center;">Ground terminal with jumper (shaded in the figure) to enable/disable the EMC filter function</p> <p style="text-align: center;">When not using the DCL, do not remove the jumper from terminals PD and P.</p> <p>[Method of enabling/disabling the EMC filter function]</p> <div style="display: flex; justify-content: space-around;"> <div style="text-align: center;"> <p>Enabling the EMC filter</p> </div> <div style="text-align: center;"> <p>Disabling the EMC filter (factory setting)</p> </div> </div>	<p>L700-185 to L700-220LFF L700-185 to L700-300HFF</p> <p>R0 and T0: M4 Ground terminal: M6 Other terminals: M6</p> <p>L700-300LFF</p> <p>R0 and T0: M4 Ground terminal: M6 Other terminals: M8</p>

Chapter 2 Installation and Wiring

Terminal layout	Inverter model
<p>Charge lamp</p> <p>R0 T0</p> <p>G (L1) S (L2) T (L3) PD (+1) P (+) N (-) U (T1) V (T2) W (T3) G</p> <p>Ground terminal with jumper (shaded in the figure) to enable/disable the EMC filter function</p> <p>Jumper connecting terminals PD and P</p> <p>When not using the DCL, do not remove the jumper from terminals PD and P.</p> <p>[Method of enabling/disabling the EMC filter function]</p> <p>Enabling the EMC filter</p> <p>Disabling the EMC filter (factory setting)</p>	<p>L700-370LFF</p> <p>R0 and T0: M4 Ground terminal: M6 Other terminals: M8</p> <hr/> <p>L700-370HFF</p> <p>R0 and T0: M4 Ground terminal: M6 Other terminals: M6</p>
<p>charge lamp</p> <p>R0 T0</p> <p>R (L1) S (L2) T (L3) PD (+1) P (+) N (-) U (T1) V (T2) W (T3) G</p> <p>Jumper connecting Terminals PD and P</p> <p>Ground terminal with jumper (shaded in the figure) to enable/disable the EMC filter function</p> <p>When not using the DCL, do not remove the jumper from terminals PD and P.</p> <p>[Method of enabling/disabling the EMC filter function]</p> <p>Enabling the EMC filter</p> <p>Disabling the EMC filter (factory setting)</p>	<p>L700-450LFF L700-450HFF L700-550LFF L700-550HFF L700-750HFF</p> <p>R0 and T0: M4 Ground terminal: M8 Other terminals: M8</p>

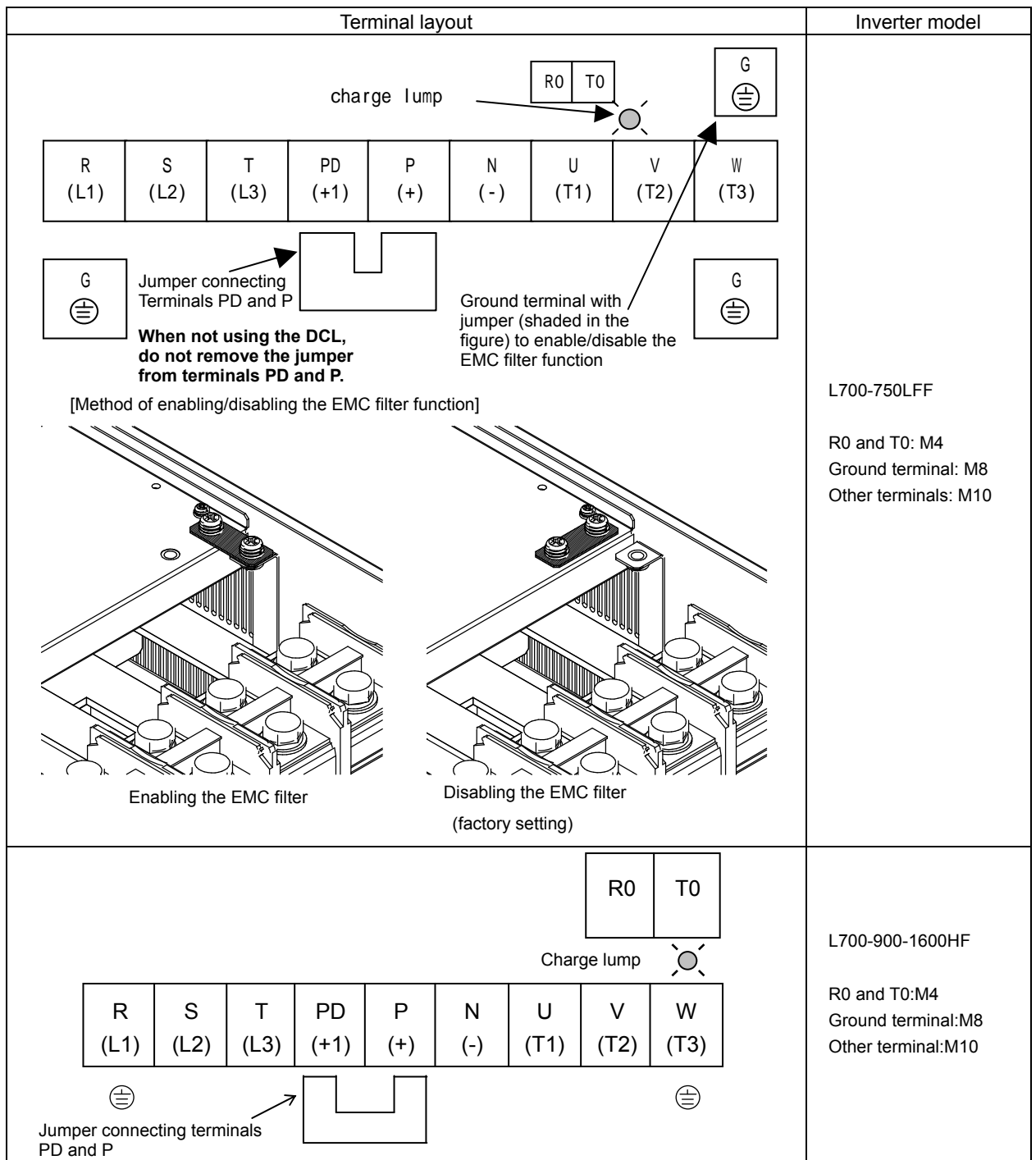

Reference: Leakage current by inverter with model EMC filter enabled or disabled (reference data)

The table below lists the reference currents that may leak from the inverter when the internal EMC filter is enabled or disabled. (Leakage current is in proportion to the voltage and frequency of input power.)

Note that the values listed in the table below indicate the reference currents leaking from the inverter alone. The values exclude current leakage from external devices and equipment (e.g., power cables).

The drive in the range from 90kW to 160kW doesn't have the switch to activate and deactivate the internal EMC filter. They complies EMC directive C3 level in standard condition.

	200 V class model (input power: 200 VAC, 50 Hz)		400 V class model (input power: 400 VAC, 50 Hz)		
	11kW, 15kW	18.5kW to 75kW	11kW, 15kW	18.5kW to 75kW	90kW to 160kW
Internal EMC filter enabled	Ca 48mA	Ca 23mA	Ca.95mA	Ca.56mA	-
Internal EMC filter disabled	Ca.0.1mA	Ca.0.1mA	Ca.0.2mA	Ca.0.2mA	Ca.0.2mA

Chapter 2 Installation and Wiring

(3) Applicable peripheral equipment

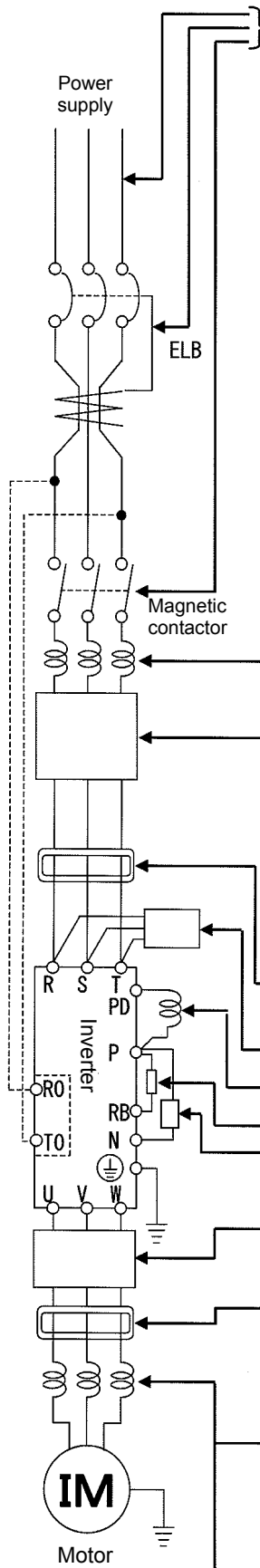

See Item (4), "Recommended cable gauges, wiring accessories, and crimp terminals."

- Note 1: The peripheral equipment described here is applicable when the inverter connects a standard Hitachi 3-phase, 4-pole squirrel-cage motor.
- Note 2: Select breakers that have proper capacity. (Use breakers that comply with inverters.)
- Note 3: Use earth-leakage breakers (ELB) to ensure safety.
- Note 4: Use copper electric wire (HIV cable) of which the maximum allowable temperature of the insulation is 75°C.
- Note 5: If the power line exceeds 20 m, cable that is thicker than the specified applicable cable must be used for the power line.
- Note 6: Use a 0.75 mm² cable to connect the alarm output contact.
- Note 7: Tighten each terminal screw with the specified tightening torque. Loose terminal screws may cause short circuits and fire. Tightening a terminal screw with excessive torque may cause damage to the terminal block or inverter body.
- Note 8: Select an earth-leakage breaker (ELB) of which the rated sensitivity current matches the total length of cables connected between the inverter and power supply and between the inverter and motor. Do not use a high-speed type ELB but use a delayed-type ELB because the high-speed type may malfunction.
- Note 9: When a CV cable is used for wiring through a metal conduit, the average current leakage is 30 mA/km.
- Note 10: When an IV cable, which has a high relative dielectric constant, is used, the leakage current is about eight times as high as the standard cable. Therefore, when using an IV cable, use the ELB of which the rated sensitivity current is eight times as high as that given in the table below. If the total cable length exceeds 100 m, use a CV cable.

Total cable length	Sensitivity current (mA)
100 m or less	50
300 m or less	100

Name	Description
Reactor on input side (for harmonic control, power supply coordination, and power factor improvement) (ALI-XXX)	Use this reactor to control harmonic waves or when the imbalance of power supply voltage is 3% or more, when the power supply capacity is 500 kVA or more, or when the power voltage may change rapidly. This reactor also improves the power factor.
Noise filter for inverter (NF-XXX)	This noise filter reduces the conductive noise that is generated by the inverter and transmitted in cables. Connect this noise filter to the primary side (input side) of the inverter.
Radio noise filter (Zero-phase reactor) (ZCL-X)	The inverter may generate radio noise through power supply wiring during operation. Use this noise filter to reduce the radio noise (radiant noise).
Radio noise filter on input side (Capacitor filter) (CFI-X)	Use this noise filter to reduce the radiant noise radiated from input cables.
DC reactor (DCL-X-XX)	Use this reactor to control the harmonic waves generated by the inverter.
Braking resistor Regenerative braking unit	Use these devices to increase the braking torque of the inverter for operation in which the inverter turns the connected load on and off very frequently or decelerates the load running with a high moment of inertia.
Noise filter on the output side (ACF-CX)	Connect this noise filter between the inverter and motor to reduce the radiant noise radiated from cables for the purpose of reducing the electromagnetic interference with radio and television reception and preventing malfunctions of measuring equipment and sensors.
Radio noise filter (Zero-phase reactor) (ZCL-XXX)	Use this noise filter to reduce the noise generated on the output side of the inverter. (This noise filter can be used on both the input and output sides.)
AC reactor for the output side For reducing vibrations and preventing thermal relay malfunction (ACL-X-XX)	Using the inverter to drive a general-purpose motor may cause larger vibrations of the motor when compared with driving it directly with the commercial power supply. Connect this AC reactor between the inverter and motor to lessen the pulsation of motor. Also, connect this AC reactor between the inverter and motor, when the cable length between them is long (10 m or more), to prevent thermal relay malfunction due to the harmonic waves that are generated by the switching operation on the inverter. Note that the thermal relay can be replaced with a current sensor to avoid the malfunction.
LCR filter	This filter converts the inverter output into a sinusoidal waveform.

(4) Recommended cable gauges, wiring accessories, and crimp terminals

Note: For compliance with CE and UL standards, see the safety precautions concerning EMC and the compliance with UL and cUL standards under Safety Instructions.

The table below lists the specifications of cables, crimp terminals, and terminal screw tightening torques for reference.

	Motor output (kW)	Applicable inverter model	Gauge of power line cable (mm ²) (Terminals: R, S, T, U, V, W, P, PD, and N)	Grounding cable (mm ²)	External braking resistor across terminals P and RB (mm ²)	Size of terminal screw	Crimp terminal	Tightening torque (N·m)	Applicable device	
									Earth-leakage breaker (ELB)	Magnetic contactor (MC)
200 V class	11	L700-110LFF	14	14	14	M5	R14-5	2.4(MAX4.0)	RX100 (75A)	HK50
	15	L700-150LFF	22	22	14	M6	22-6	4.0(MAX4.4)	RX100 (100A)	H65
	18.5	L700-185LFF	30	22	22	M6	38-6	4.5(MAX4.9)	RX100 (100A)	H80
	22	L700-220LFF	38	30	22	M6	38-6	4.5(MAX4.9)	RX225B (150A)	H100
	30	L700-300LFF	60 (22×2)	30	30	M8	R60-8	8.1(MAX8.8)	RX225B (200A)	H125
	37	L700-370LFF	100 (38×2)	38	—	M8	100-8	8.1(MAX8.8)	RX225B (225A)	H150
	45	L700-450LFF	100 (38×2)	38	—	M8	100-8	8.1(MAX20)	RX225B (225A)	H200
	55	L700-550LFF	150 (60×2)	60	—	M8	150-8	8.1(MAX20)	RX400B (350A)	H250
	75	L700-750LFF	150 (60×2)	80	—	M10	R150-10	19.5(MAX22)	RX400B (350A)	H300
400 V class	11	L700-110HFF	5.5	5.5	5.5	M5	R5-5-5	2.4(MAX4.0)	EX50C (30A)	HK35
	15	L700-150HFF	8	8	5.5	M6	R8-6	4.0(MAX4.4)	EX60B (60A)	HK35
	18.5	L700-185HFF	14	14	8	M6	R14-6	4.5(MAX4.9)	EX60B (60A)	HK50
	22	L700-220HFF	14	14	8	M6	R14-6	4.5(MAX4.9)	RX100 (75A)	HK50
	30	L700-300HFF	22	22	14	M6	R22-6	4.5(MAX4.9)	RX100 (100A)	H65
	37	L700-370HFF	38	22	—	M6	38-6	4.5(MAX4.9)	RX100 (100A)	H80
	45	L700-450HFF	38	22	—	M8	R38-8	8.1(MAX20)	RX225B (150A)	H100
	55	L700-550HFF	60	30	—	M8	R60-8	8.1(MAX20)	RX225B (175A)	H125
	75	L700-750HFF	100(38X2)	38	—	M8	100-8	8.1(MAX20)	RX225B(225A)	H150
	90	L700-900HF	100(38X2)	38	—	M10	R100-10	20.0(MAX22)	RX225B(225A)	H200
	110	L700-1100HF	150(60X2)	60	—	M10	R150-10	20.0(MAX35)	RX400B(350A)	H250
	132	L700-1320HF	80X2	80	—	M10	80-10	20.0(MAX35)	RX400B(350A)	H300
	160	L700-1600HF	100X2	80	—	M10	R100-10	20.0(MAX35)	RX400B(350A)	H400

Note: Cable gauges indicate those of HIV cables (maximum heat resistance: 75°C).

*1) Please use the round type crimp terminals (for the UL standard) suitable for the use electric wire when you connect the electric wire with the main circuit terminal stand. Please put on pressure to the crimp terminals I with a crimp tool that the terminal stand maker recommends.

(5) Connecting the control circuit to a power supply separately from the main circuit

If the protective circuit of the inverter operates to open the magnetic contactor in the input power supply circuit, the inverter control circuit power is lost, and the alarm signal cannot be retained.

To retain the alarm signal, connect control circuit terminals R0 and T0 to a power supply.

In details, connect the control circuit power supply terminals R0 and T0 to the primary side of the magnetic contactor as shown below.

(Connection method)

Power-receiving specifications

200 V class model:
200 to 240 V (+10%, -15%)
(50/60 Hz ±5%),(282 to 339 VDC)

400 V class model:
380 to 480 V (+10%, -15%)
(50/60 Hz ±5%),(537 to 678 VDC)

Remove the connected cables.

Remove the J51 connector.

Connect the control circuit power supply cables to the control circuit power supply terminal block.

Note the following when connecting separate power supplies to control circuit power supply terminals (R0 and T0) and main circuit power supply terminals (R, S, and T):

- Use a cable thicker than 1.25 mm² to connect the terminals R0 and T0 (terminal screw size: M4).
- Connect a 3 A fuse in the control circuit power supply line. (Tightening torque:1.2Nm,max torque:1.4Nm)
- If the control circuit power supply (connected to R0 and T0) is turned on earlier than the main circuit power supply (connected to R, S, and T), ground fault is not checked at power-on.
- When supplying DC power to the control circuit power supply terminals (R0 and T0), specify "00" as the "a/b (NO/NC)" selection (function code C031 to C036) for intelligent output terminals ([11] to [15]) and intelligent relay terminals (AL0, AL1, and AL2). If "01" is specified as the "a/b (NO/NC)" selection, output signals may chatter when the DC power supply is shut off.

Chapter 2 Installation and Wiring

2.2.3 Wiring of the control circuit

(1) Wiring instructions

- 1) Terminals L and CM1 are common to I/O signals and isolated from each other.
Do not connect these common terminals to each other or ground them.
Do not ground these terminals via any external devices. (Check that the external devices connected to these terminals are not grounded.)
- 2) Use a shielded, twisted-pair cable (recommended gauge: 0.75 mm²) for connection to control circuit terminals, and connect the cable insulation to the corresponding common terminal. (Tightening torque:0.7Nm,max torque:0.8Nm)
- 3) The length of cables connected to control circuit terminals must be 20 m or less. If the cable length exceeds 20 m unavoidably, use a VX-compatible controller (CVD-E) insulated signal converter.
- 4) Separate the control circuit wiring from the main circuit wiring (power line) and relay control circuit wiring.
If these wirings intersect with each other unavoidably, square them with each other. Otherwise, the inverter may malfunction.
- 5) Twist the cables connected from a thermistor to the thermistor input terminal (TH) and terminal CM1, and separate the twisted cables from other cables connected to other common terminals.
Since very low current flows through the cables connected to the thermistor, separate the cables from those (power line cables) connected to the main circuit. The length of the cables connected to the thermistor must be 20 m or less.

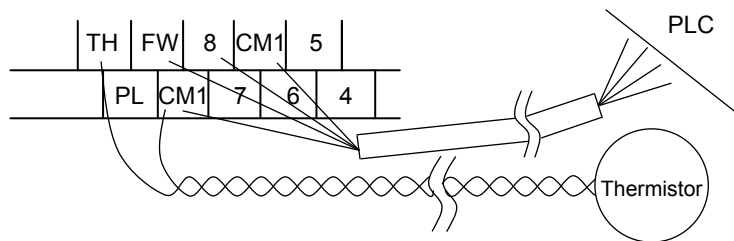

- 6) When connecting a contact to a control circuit terminal (e.g., an intelligent input terminal), use a relay contact (e.g., crossbar twin contact) in which even a very low current or voltage will not trigger any contact fault.
- 7) When connecting a relay to an intelligent output terminal, also connect a surge-absorbing diode in parallel with the relay.
- 8) Do not connect analog power supply terminals H and L or interface power supply terminals P24 and CM1 to each other.
Otherwise, the inverter may fail.

(2) Layout of control circuit terminals

H	O2	AM	FM	TH	FW	8	CM1	5	3	1	14	13	11	AL1	
L	O	OI	AMI	P24	PLC	CM1	7	6	4	2	15	CM2	12	AL0	AL2

Terminal screw size: M3(Tightening torque:0.7Nm,max torque:0.8Nm)

(3) Switching the input control logic

- In the factory setting, the input control logic for terminal FW and intelligent input terminals is the sink logic.
To switch the input control logic to the source logic, remove the jumper connecting terminals P24 and PLC on the control circuit block, and then connect terminals PLC and CM1 with the jumper.

(4) Connecting a programmable controller to intelligent input terminals

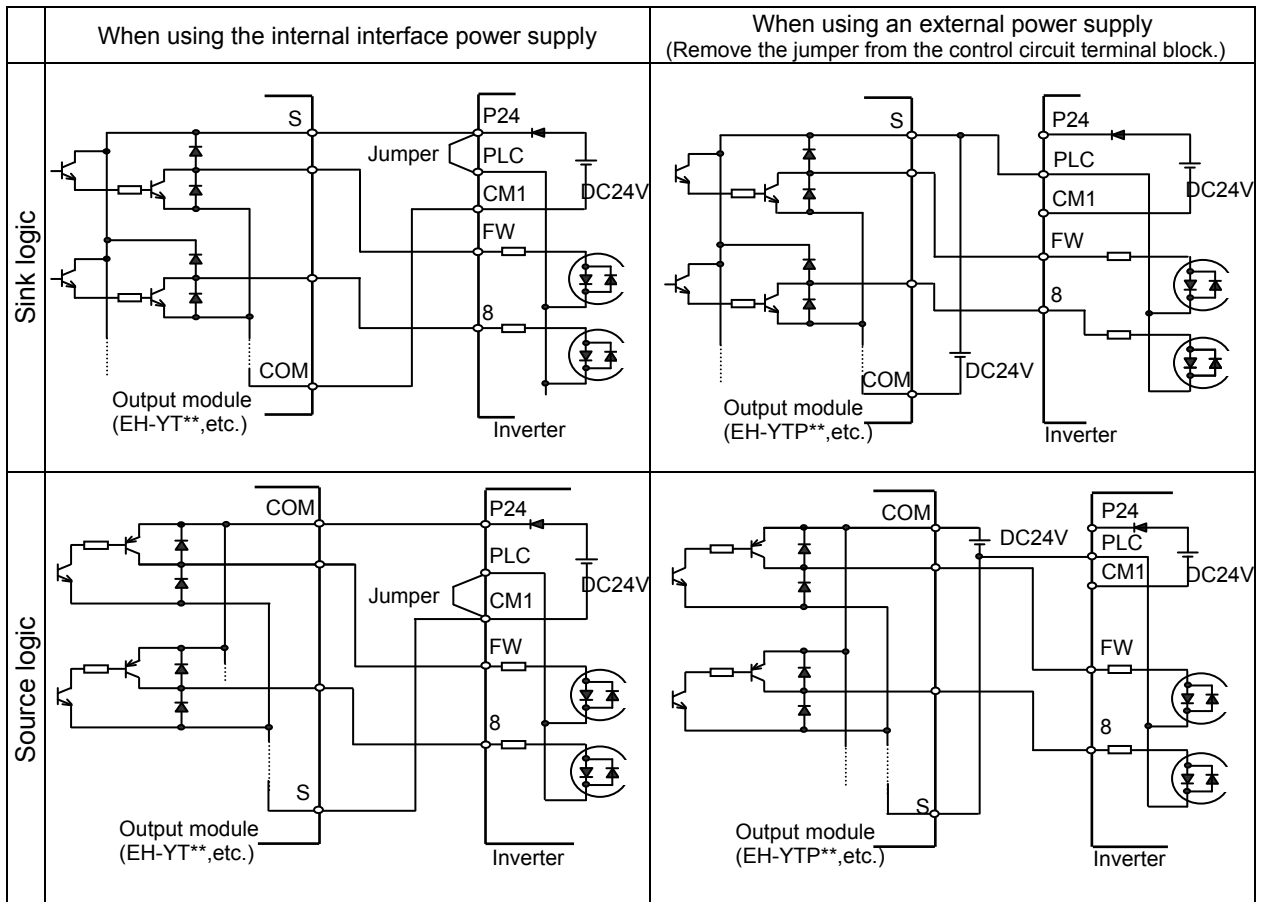

(5) Connecting a programmable controller to intelligent output terminals

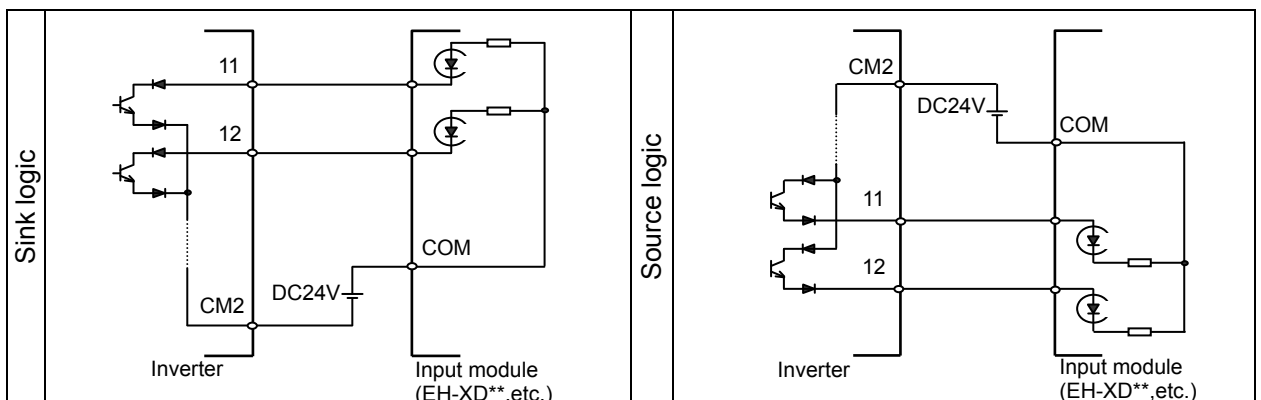

2.2.4 Wiring of the digital operator

- You can operate the inverter with not only the digital operator mounted in the inverter as standard equipment but also an optional digital operator (OPE-S, OPE-SR, SRW-OJ, or SRW-OEX).
- When you intend to remove the standard digital operator from the inverter and use it as remote equipment, request your local Hitachi Distributor to supply a connection cable, ICS-1 (1-meter cable) or ICS-3 (3-meter cable).

If you prepare the cable by yourself, the following product is recommended:

HUTP5 PC 4P -X-X: Straight cable equipped with connector at both ends (made by Hitachi Cable, Ltd.)

- The length of the connection cable must be 3 m or less. If a cable over 3 m is used, the inverter may malfunction.

Chapter 2 Installation and Wiring

2.2.5 Selection and wiring of regenerative braking resistor (on 11 kW to 30 kW models)

The L700 series inverter models with capacities of 11 to 30 kW have an internal regenerative braking circuit.

Connecting an optional regenerative braking resistor to RB and P terminals increases the regenerative torque.

Model	Motor capacity (kW)	Without a resistor connected	Minimum connectable resistor			Minimum resistance during continuous operation ()
		Regenerative torque (%)	Resistance ()	Regenerative torque (%)	BRD usage rate (%)	
L700-110LFF	11	10	10	110	10	50
L700-150LFF	15	10	10	80	10	50
L700-185LFF	18.5	10	7.5	90	10	35
L700-220LFF	22	10	7.5	70	10	35
L700-300LFF	30	10	5	80	10	35
L700-110HFF	11	10	35	120 over	10	150
L700-150HFF	15	10	35	90	10	100
L700-185HFF	18.5	10	24	110	10	100
L700-220HFF	22	10	24	90	10	100
L700-300HFF	30	10	20	80	10	100

Chapter 3 Operation

This chapter describes typical methods of operating the inverter, how to operate the digital operator, and how to make a test run of the inverter.

3.1	Operating Methods.....	3 - 2
3.2	How To Operate the Digital Operator	3 - 4

3.1 Operating Methods

WARNING

- While power is supplied to the inverter, do not touch any terminal or internal part of the inverter, check signals, or connect or disconnect any wire or connector. Otherwise, you run the risk of electric shock or fire.
- Be sure to close the terminal block cover before turning on the inverter power. Do not open the terminal block cover while power is being supplied to the inverter or voltage remains inside. Otherwise, you run the risk of electric shock.
- Do not operate switches with wet hands. Otherwise, you run the risk of electric shock.
- While power is supplied to the inverter, do not touch the terminal of the inverter, even if it has stopped. Otherwise, you run the risk of injury or fire.
- If the retry mode has been selected, the inverter will restart suddenly after a break in the tripping status. Stay away from the machine controlled by the inverter when the inverter is under such circumstances. (Design the machine so that human safety can be ensured, even when the inverter restarts suddenly.) Otherwise, you run the risk of injury.
- Do not select the retry mode for controlling an elevating or traveling device because output free-running status occurs in retry mode. Otherwise, you run the risk of injury or damage to the machine controlled by the inverter.
- If an operation command has been input to the inverter before a short-term power failure, the inverter may restart operation after the power recovery. If such a restart may put persons in danger, design a control circuit that disables the inverter from restarting after power recovery. Otherwise, you run the risk of injury.
- The [STOP] key is effective only when its function is enabled by setting. Prepare an emergency stop switch separately. Otherwise, you run the risk of injury.
- If an operation command has been input to the inverter before the inverter enters alarm status, the inverter will restart suddenly when the alarm status is reset. Before resetting the alarm status, make sure that no operation command has been input.
- While power is supplied to the inverter, do not touch any internal part of the inverter or insert a bar in it. Otherwise, you run the risk of electric shock or fire.

CAUTION

- Do not touch the heat sink, which heats up during the inverter operation. Otherwise, you run the risk of burn injury.
- The inverter allows you to easily control the speed of motor or machine operations. Before operating the inverter, confirm the capacity and ratings of the motor or machine controlled by the inverter. Otherwise, you run the risk of injury and damage to machine.
- Install an external brake system if needed. Otherwise, you run the risk of injury.
- When using the inverter to operate a standard motor at a frequency of over 60 Hz, check the allowable motor speeds with the manufacturers of the motor and the machine to be driven and obtain their consent before starting inverter operation. Otherwise, you run the risk of damage to the motor and machine and injury.
- During inverter operation, check the motor for the direction of rotation, abnormal sound, and vibrations. Otherwise, you run the risk of damage to the machine driven by the motor.

You can operate the inverter in different ways, depending on how to input the operation and frequency-setting commands as described below.
This section describes the features of operating methods and the items required for operation.

- (1) Entering operation and frequency-setting commands from the digital operator
This operating method allows you to operate the inverter through key operations on the standard digital operator mounted in the inverter or an optional digital operator.
When operating the inverter with a digital operator alone, you need not wire the control circuit terminals.

(Items required for operation)

- 1) Optional digital operator (not required when you use the standard digital operator)

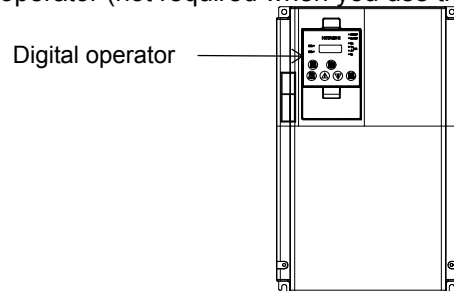

- (2) Entering operation and frequency-setting commands via control circuit terminals
This operating method allows you to operate the inverter via the input of operation signals from external devices (e.g., frequency-setting circuit and start switch) to control circuit terminals.
The inverter starts operation when the input power supply is turned on and then an operation command signal (FW or RV) is turned on.

You can select the frequency-setting method (setting by voltage specification or current specification) through the input to a control circuit terminal according to your system. For details, see Item (2), "Explanation of control circuit terminals," in Section 2.2.1 (on pages 2-7 and 2-8).

(Items required for operation)

- 1) Operation command input device: External switch or relay
2) Frequency-setting command input device: External device to input signals (0 to 10 VDC, -10 to +10 VDC, or 4 to 20 mA)

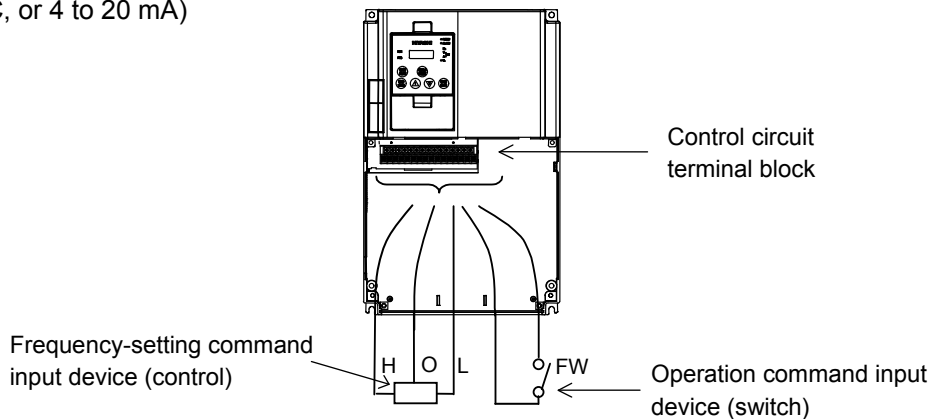

- (3) Entering operation and frequency-setting commands; both from a digital operator and via control circuit terminals

This operating method allows you to arbitrarily select the digital operator or control circuit terminals as the means to input operation commands and frequency-setting commands.

(Items required for operation)

- 1) See the items required for the above two operating methods.

- (4) Method for operation in Easy sequence function

The inverter can be operated by downloading the user's program made with exclusive use PC software EzSQ. Please refer to "Easy sequence function" for details.

- (5) Method for operation in Telecommunication facility

It is possible to use RS485 from TM2 that exists in Control terminal board of the inverter, and to operate it by the inverter and communicating with external telecommunications equipment. Please refer to "Communication facility" for details.

Chapter 3 Operation

3.2 How To Operate the Digital Operator (OPE-SBK)

3.2.1 Names and functions of components

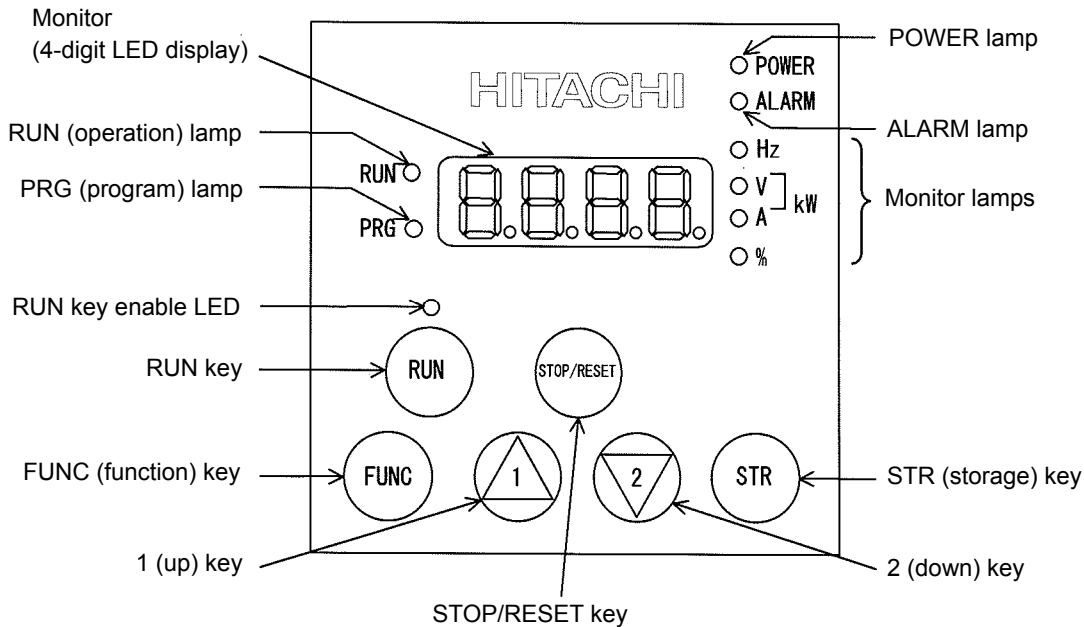



Name	Function
POWER lamp	Lights when the control circuit power is on.
ALARM lamp	Lights to indicate that the inverter has tripped.
RUN (operation) lamp	Lights to indicate that the inverter is operating.
PRG (program) lamp	Lights when the monitor shows a value set for a function. This lamp starts blinking to indicate a warning (when the set value is invalid).
Monitor	Displays a frequency, output current, or set value.
Monitor lamps	Indicates the type of value and units displayed on the monitor. "Hz" (frequency), "V" (voltage), "A" (current), "kW" (electric power), and "%" (percentage)
RUN key enable LED	Lights up when the inverter is ready to respond to the RUN key. (When this lamp is on, you can start the inverter with the RUN key on the digital operator.)
RUN key	Starts the inverter to run the motor. This key is effective only when the operating device is the digital operator. (To use this key, confirm that the operating device indicator lamp is on.)
STOP/RESET key	Decelerates and stops the motor or resets the inverter from alarm status.
FUNC (function) key	Makes the inverter enter the monitor, function, or extended function mode.
STR (storage) key	Stores each set value. (Always press this key after changing a set value.)
1 (up) or 2 (down) key	Switches the inverter operation mode (among monitor, function, and extended function modes) or increases or decreases the value set on the monitor for a function.

3.2.2 Code display system and key operations

This section describes typical examples of digital operator operation (in basic and full display modes) and an example of special digital operator operation in extended function mode U.



The initial display on the monitor screen after power-on depends on the setting of function "b038". For details, see "Initial-screen selection,".



When the setting of function "b038" is "01" (factory setting), the monitor initially shows  as the setting of function "d001" (output frequency monitoring). Pressing the  key in this status changes the display to .



Note: The display contents on the monitor depend on the settings of functions "b037" (function code display restriction), "b038" (initial-screen selection), and "b039" (automatic setting of user parameters). For details, see, "Function code display restriction," "Initial-screen selection," and "Automatic user-parameter setting,".

Item	Function code	Data	Description
Function code display restriction	b037	00	Full display
		01	Function-specific display
		02	User setting
		03	Data comparison display
		04	Basic display (factory setting)
Initial-screen selection (Initial display at power-on)	b038 (*1)	00	Screen displayed when the [STR] key was pressed last (same as the operation on the SJ300 series)
		01	d001 (output frequency monitoring)
		02	d002 (output current monitoring)
		03	d003 (rotation direction minitoring)
		04	d007 (Scaled output frequency monitoring)
		05	F001 (output frequency setting)
Selection of automatic user-parameter settings	b039 (*1)	00	Disable
		01	Enable

*1 Not displayed with the factory setting

* The following procedure enables you to turn the monitor display back to  or  (*1) regardless of the current display mode:

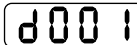
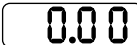
- Hold down the  key for 3 seconds or more. The monitor shows  and  (*1) alternately.

During this status, press the  key. The monitor will show only  or  (*1), which is shown when the  is pressed.

*1 The monitor shows  only when the motor driven by the inverter is stopped. While the motor is running, the monitor shows an output frequency.

Chapter 3 Operation

(1) Example of operation in basic display mode ("b037" = "04" [factory setting])

- Only basic parameters can be displayed in basic display mode. (All parameters in monitor mode, four parameters in function mode, or 20 parameters in extended function mode)
- Other parameters are not displayed. To display all parameters, select the full display mode ("b037" = "00").

<Displayable parameters and sequence of display>

No.	Display code	Item
1	d001 to d104	Monitor display
2	F001	Output frequency setting
3	F002	Acceleration (1) time setting
4	F003	Deceleration (1) time setting
5	F004	Operation direction setting
6	A001	Frequency source setting
7	A002	Run command source setting
8	A003	Base frequency setting
9	A004	Maximum frequency setting
10	A005	[AT] selection
11	A020	Multispeed frequency setting
12	A021	Multispeed 1 setting
13	A022	Multispeed 2 setting
14	A023	Multispeed 3 setting
15	A044	1st control method
16	A045	V/f gain setting
17	A085	Operation mode selection
18	b001	Selection of restart mode
19	b002	Allowable under-voltage power failure time
20	b008	Retry-after-trip selection
21	b011	Retry wait time after trip
22	b037	Function code display restriction
23	b083	Carrier frequency setting
24	b084	Initialization mode selection
25	b130	Selection of overvoltage suppression function
26	b131	Setting of overvoltage suppression level
27	C021	Setting of intelligent output terminal 11
28	C022	Setting of intelligent output terminal 12
29	C036	Alarm relay active state

Note:

If a desired parameter is not displayed, check the setting of function "b037" (function code display restriction). To display all parameters, specify "00" for "b037".

Key operation and transition of the codes on display

Key operation and transition of the monitored data on display

Pressing the \triangle or ∇ key respectively scrolls up or down the code displayed in code display mode or increases or decreases the numerical data displayed in data display mode.

Press the \triangle or ∇ key until the desired code or numerical data is shown. To scroll codes or increase/decrease numerical data faster, press and hold the key.

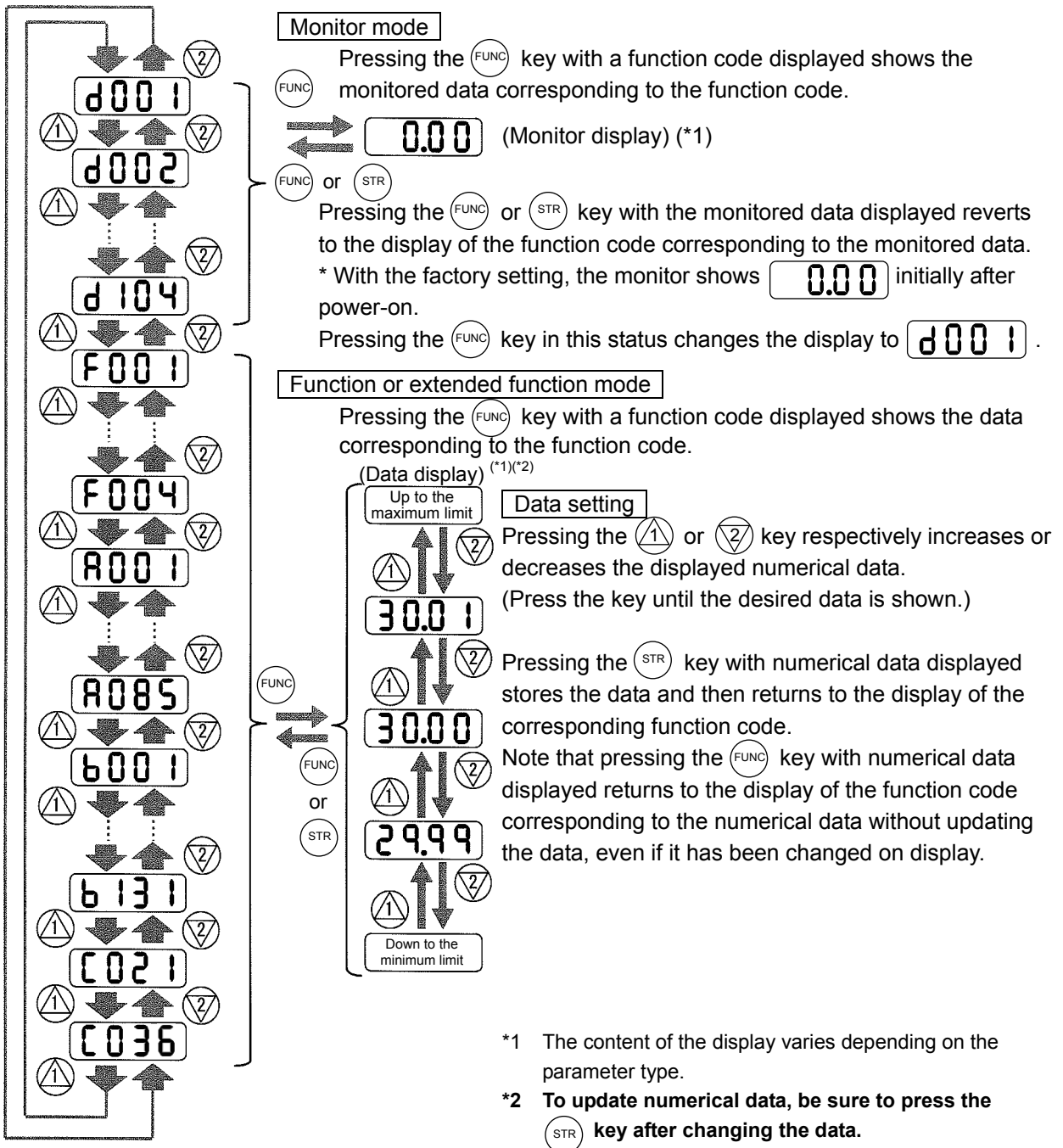

Chapter 3 Operation

(2) Example of operation in full display mode ("b037" = "00")

All parameters can be displayed in full display mode. The display sequence of parameters matches their sequence shown in Chapter 8, "List of Data Settings."

Key operation and transition of codes on display (in monitor or function mode)

Key operation and transition of monitored data on display (in monitor or function mode)

Key operation and transition of codes on display (in extended function mode)

Key operation and transition of monitored data on display (in extended function mode)

Pressing the Δ or ∇ key respectively scrolls up or down the code displayed in code display mode or increases or decreases the numerical data displayed in data display mode.

Press the Δ or ∇ key until the desired code or numerical data is shown. To scroll codes or increase/decrease numerical data fast, press and hold the key.

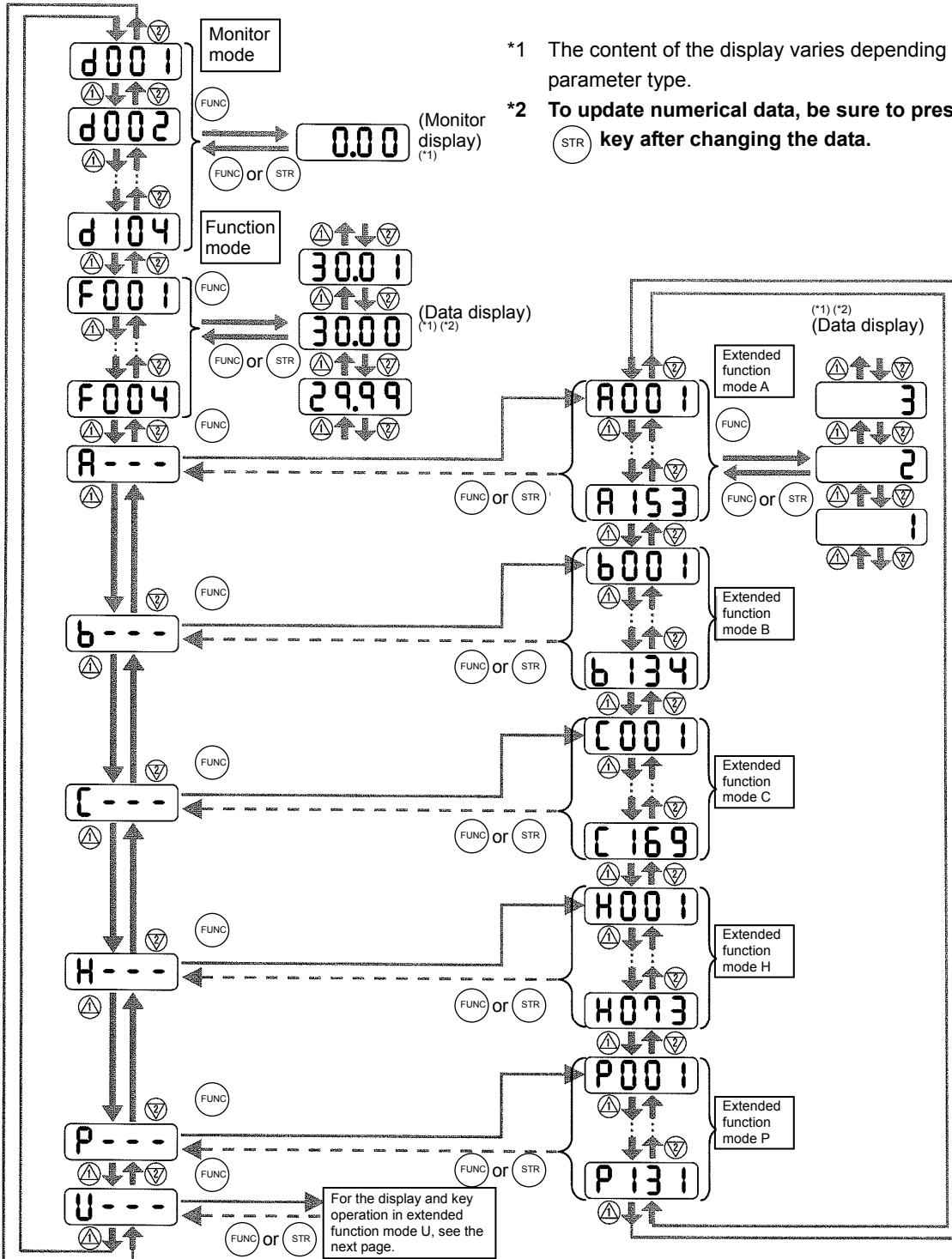

*1 The content of the display varies depending on the parameter type.

*2 To update numerical data, be sure to press the STR key after changing the data.

(3) Code/data display and key operation in extended function mode U

The extended function mode U differs in operation from other extended function modes because the extended function mode U is used to register (or automatically record) other extended-function codes as user-specified U parameters.

Key operation and transition of codes on display (in monitor or function mode)

Key operation and transition of codes on display (in extended function mode U)

Key operation and transition of codes on display (when displaying extended-function mode parameters from the extended function mode U)

Key operation and transition of codes on display (in monitor, function, or extended

*1 The content of the display varies depending on the parameter type.

*2 To update numerical data, be sure to press the **STR** key after changing the data.

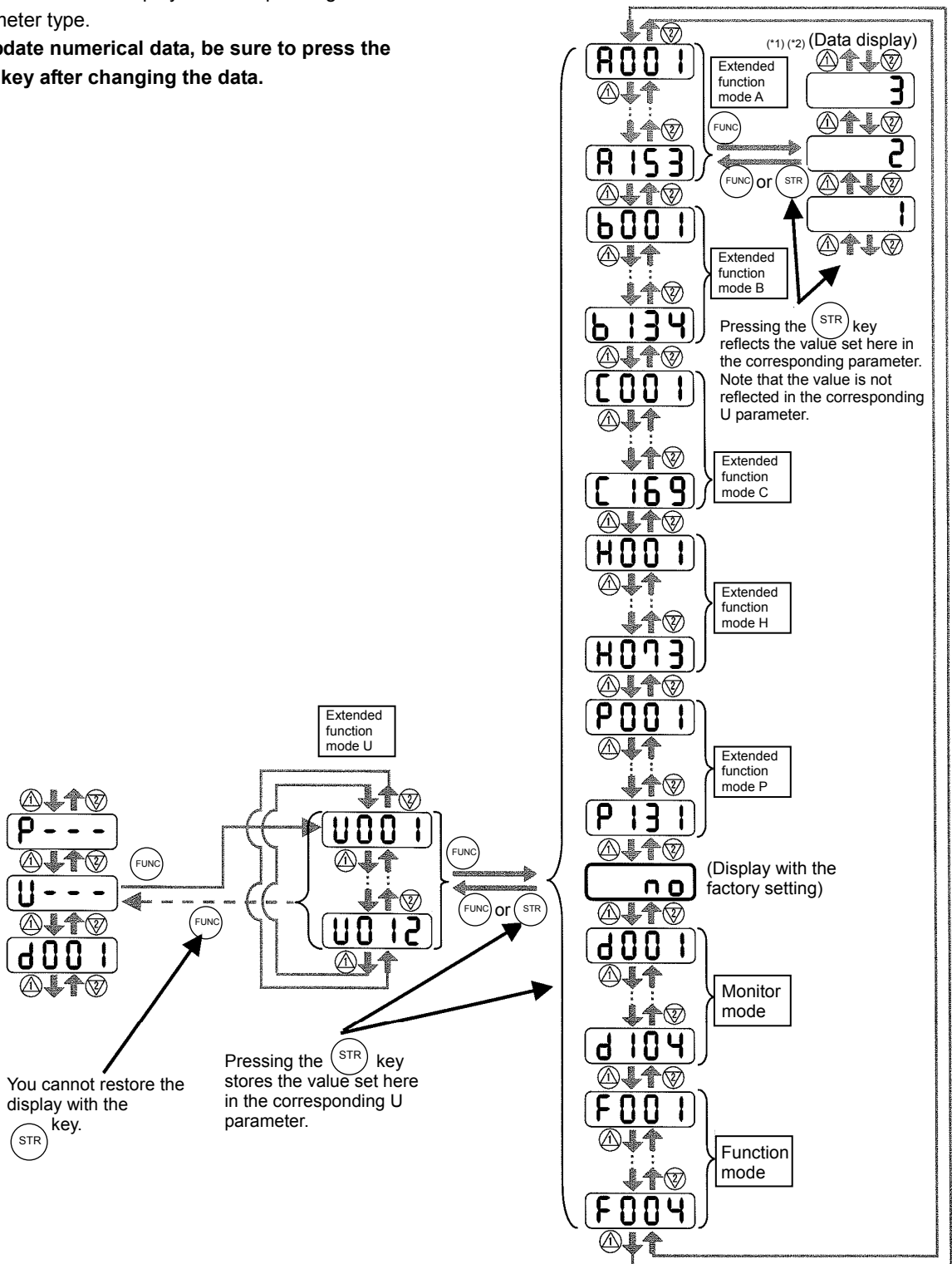

Chapter 3 Operation

(4) Procedure for directly specifying or selecting a code

- You can specify or select a code or data by entering each digit of the code or data instead of scrolling codes or data in the monitor, function, or extended function mode.
- The following shows an example of the procedure for changing the monitor mode code "d001" displayed to extended function code "A029":

1) Display the monitor mode code.
("d001" is displayed.)

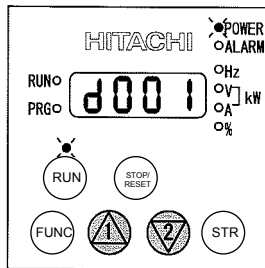

(*2)

(*3)

Press the **FUNC** key, then the **1** and **2** keys together. (*1)

2) Change to the extended function mode.

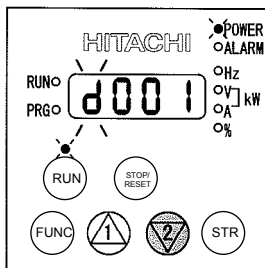

- Character "d" in the leftmost digit (fourth digit from the right) starts blinking.

Press the **2** key twice.
("A001" is displayed.)

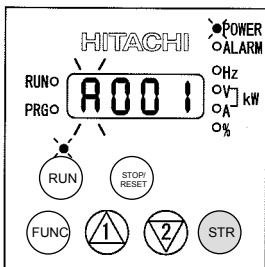

(*3)

- Character "A" is blinking.
- Pressing the [STR] key determines the blinking character.

(*2)

Press the **STR** key (to determine character "A").

3) Change the third digit of the code.

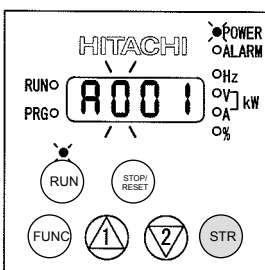

Press the **STR** key.

(Character "0" is determined.)

Press the **FUNC** key. (*2)

- Character "0" in the third digit is blinking.
- Since the third digit need not be changed, press the [STR] key to determine the character "0".

("A029" is displayed.)

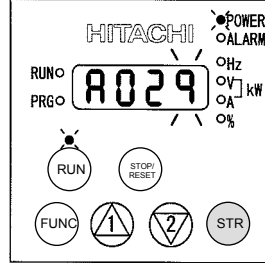

(*2)

6) End the change of the extended function code.

Press the **STR** key.

(Character "9" is determined.)

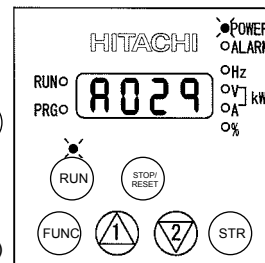

- Character "9" in the first digit is blinking.

Press the **1** key eight times or the **2** key twice.

5) Change the first digit of the code.

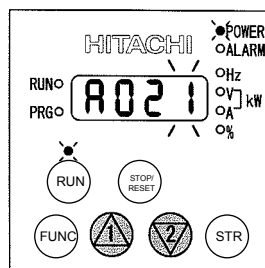

- Character "1" in the first digit is blinking.

Press the **STR** key. (*2)

(Character "A" is determined.)

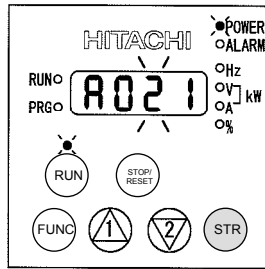

(*2)

- Character "2" in the second digit is blinking.

Press the **1** key twice.

4) Change the second digit of the code.

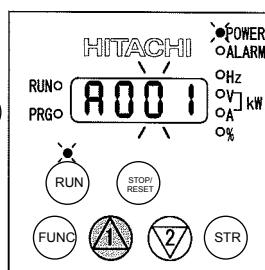

- Character "0" in the second digit is blinking.

- Selection of code "A029" is completed.

* If a code that is not defined in the code list or not intended for display is entered, the leftmost digit (fourth digit) (character "A" in this example) will start blinking again.

In such a case, confirm the code to be entered and enter it correctly. For further information, refer to Section 4.2.84. "Function code display restriction," (on page 4-79), Section 4.2.85. "Initial-screen selection," (on page 4-81), Section 4.2.86. "Automatic user-parameter setting," (on page 4-82), and Chapter 8, "List of Data Settings."

7) Press the **FUNC** key to display the data corresponding to the function code, change the data with the **1** and/or **2** key, and then press the **STR** key to store the changed data. (*4)

Note that you can also use the procedure (steps 1) to 6)) described here to change the data. (*3)(*4)

*1

This procedure can also be used on screens displaying a code other than "d001".

*2

If the **FUNC** key is pressed while a digit is blinking, the display will revert to the preceding status for entering the digit to the right of the blinking digit.

*3

If the **FUNC** key is pressed while the leftmost (fourth) digit is blinking, the characters having been entered to change the code will be cancelled and the display will revert to the original code shown before the **1** and **2** keys were pressed in step 1).

*4

When changing data, be sure to press the **FUNC** key first.

Chapter 4 List of Data Settings

4.1	Precautions for Data Setting	4-2
4.2	Monitoring Mode.....	4-2
4.3	Function Mode	4-3
4.4	Extended Function Mode	4-4

Chapter 4 List of Data Settings

4.1 Precautions for Data Setting

The default display mode limits the screens (parameters) that can be displayed on the monitor. To enable the display of all parameters, specify "00" (full display) for the function code display restriction (b037). To enable the parameters to be changed while the inverter is operating, specify "10" for the software lock mode selection (b031).

4.2 Monitoring Mode

With the default settings, the monitor always displays the data output according to the output frequency monitoring (d001) after power-on. To change the initial display content, change the setting of the initial-screen selection (b038) as required.

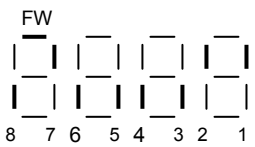
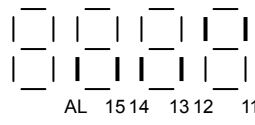
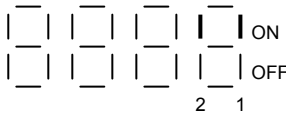
Code	Function name	Monitored data or setting	Default	Setting during operation (allowed or not)	Change during operation (allowed or not)
d001	Output frequency monitoring	0.00 to 99.99, 100.0 to 400.0 (Hz)	-	○	○
d002	Output current monitoring	0.0 to 999.9, 1000 to 9999 (A)	-	-	-
d003	Rotation direction monitoring	F (forward rotation), o (stopped), r (reverse rotation)	-	-	-
d004	Process variable (PV), PID feedback monitoring	0.00 to 99.99, 100.0 to 999.9, 1000. to 9999. 1000 to 9999 (10000 to 99990), $\bar{1}$ 100 to $\bar{1}$ 999 (100000 to 999000)	-	-	-
d005	Intelligent input terminal status	 <p>FW (Example) Terminals FW, 7, 2, and 1: ON Terminals 8, 6, 5, 4, and 3: OFF</p>	-	-	-
d006	Intelligent output terminal status	 <p>(Example) Terminals 12 and 11: ON Terminals AL, 15, 14, and 13: OFF</p>	-	-	-
d007	Scaled output frequency monitoring	0.00 to 99.99, 100.0 to 999.9, 1000. to 9999., 1000 to 3996 (10000 to 39960)	-	○	○
d012	Torque monitoring	-200. to +200. (%)	-	-	-
d013	Output voltage monitoring	0.0 to 600.0 (V)	-	-	-
d014	Power monitoring	0.0 to 999.9 (kW)	-	-	-
d015	Cumulative power monitoring	0.0 to 999.9, 1000. to 9999.1000 to 9999 (10000 to 99990), $\bar{1}$ 100 to $\bar{1}$ 999 (100000 to 999000)	-	-	-
d016	Cumulative operation RUN time monitoring	0. to 9999., 1000 to 9999 (10000 to 99990), $\bar{1}$ 100 to $\bar{1}$ 999 (100000 to 999000) (hr)	-	-	-
d017	Cumulative power-on time monitoring	0. to 9999., 1000 to 9999 (10000 to 99990), $\bar{1}$ 100 to $\bar{1}$ 999 (100000 to 999000) (hr)	-	-	-
d018	Heat sink temperature monitoring	-020. to 200.0 (°C)	-	-	-
d019	Motor temperature monitoring	-020. to 200.0 (°C)	-	-	-
d022	Life-check monitoring	 <p>ON OFF 1: Capacitor on main circuit board 2: Cooling-fan speed drop</p>	-	-	-
d023	Program counter	0 to 1024	-	-	-
d024	Program number monitoring	0000 to 9999	-	-	-

Code	Function name	Monitored data or setting	Default	Setting during operation (allowed or not)	Change during operation (allowed or not)
d025	User monitor 0	-2147483647 to 2147483647 (upper 4 digits including "-")	-	-	-
d026	User monitor 1	-2147483647 to 2147483647 (upper 4 digits including "-")	-	-	-
d027	User monitor 2	-2147483647 to 2147483647 (upper 4 digits including "-")	-	-	-
d028	Pulse counter	0 to 2147483647 (upper 4 digits)	-	-	-
d080	Trip Counter	0. to 9999., 1000 to 6553 (10000 to 65530) (times)	-	-	-
d081	Trip monitoring 1	Factor, frequency (Hz), current (A), voltage across P-N (V), running time (hours), power-on time (hours)	-	-	-
d082	Trip monitoring 2	Factor, frequency (Hz), current (A), voltage across P-N (V), running time (hours), power-on time (hours)	-	-	-
d083	Trip monitoring 3	Factor, frequency (Hz), current (A), voltage across P-N (V), running time (hours), power-on time (hours)	-	-	-
d084	Trip monitoring 4	Factor, frequency (Hz), current (A), voltage across P-N (V), running time (hours), power-on time (hours)	-	-	-
d085	Trip monitoring 5	Factor, frequency (Hz), current (A), voltage across P-N (V), running time (hours), power-on time (hours)	-	-	-
d086	Trip monitoring 6	Factor, frequency (Hz), current (A), voltage across P-N (V), running time (hours), power-on time (hours)	-	-	-
d090	Programming error monitoring	Warning code	-	-	-
d102	DC voltage monitoring	0.0 to 999.9 (V)	-	-	-
d103	BRD load factor monitoring	0.0 to 100.0 (%)	-	-	-
d104	Electronic thermal overload monitoring	0.0 to 100.0 (%)	-	-	-

4.3 Function Mode

Code	Function name	Monitored data or setting	Default	Setting during operation (allowed or not)	Change during operation (allowed or not)
			_FF		
F001	Output frequency setting	0.0, "start frequency" to "maximum frequency" (or maximum frequency, 2nd/3rd motors) (Hz) 0.0 to 100.0 (when PID function is enabled)	0.00	○	○
F002	Acceleration (1) time setting	0.01 to 99.99, 100.0 to 999.9, 1000. to 3600. (s)	30.00	○	○
F202	Acceleration (1) time setting, 2nd motor	0.01 to 99.99, 100.0 to 999.9, 1000. to 3600. (s)	30.00	○	○
F302	Acceleration (1) time setting, 3rd motor	0.01 to 99.99, 100.0 to 999.9, 1000. to 3600. (s)	30.00	○	○
F003	Deceleration (1) time setting	0.01 to 99.99, 100.0 to 999.9, 1000. to 3600. (s)	30.00	○	○
F203	Deceleration time setting, 2nd motor	0.01 to 99.99, 100.0 to 999.9, 1000. to 3600. (s)	30.00	○	○
F303	Deceleration time setting, 3rd motor	0.01 to 99.99, 100.0 to 999.9, 1000. to 3600. (s)	30.00	○	○
F004	Keypad Run key routing	00 (forward rotation), 01 (reverse rotation)	00	×	×

Chapter 4 List of Data Settings

4.4 Extended Function Mode

Code	Function name	Monitored data or setting	Default	Setting during operation (allowed or not)	Change during operation (allowed or not)	
			_FF			
Basic settings	A001	Frequency source setting	00 (keypad potentiometer) (*1), 01 (control circuit terminal block), 02 (digital operator), 03 (RS485), 04 (option 1), 05 (option 2), 06 (pulse-string input), 07 (easy sequence), 10 (operation function result)	02	×	×
	A002	Run command source setting	01 (control circuit terminal block), 02 (digital operator), 03 (RS485), 04 (option 1), 05 (option 2)	02	×	×
	A003	Base frequency setting	30. to "maximum frequency" (Hz)	60.	×	×
	A203	Base frequency setting, 2nd motor	30. to "maximum frequency, 2nd motor" (Hz)	60.	×	×
	A303	Base frequency setting, 3rd motor	30. to "maximum frequency, 3rd motor" (Hz)	60.	×	×
	A004	Maximum frequency setting	30. to 400. (Hz)	60.	×	×
	A204	Maximum frequency setting, 2nd motor	30. to 400. (Hz)	60.	×	×
	A304	Maximum frequency setting, 3rd motor	30. to 400. (Hz)	60.	×	×
Analog input and others	A005	[AT] selection	00 (switching between O and OI terminals), 01 (switching between O and O2 terminals), 02 (switching between O terminal and keypad potentiometer) (*1), 03 (switching between OI terminal and keypad potentiometer) (*1), 04 (switching between O2 and keypad potentiometer) (*1)	00	×	×
	A006	[O2] selection	00 (single), 01 (auxiliary frequency input via O and OI terminals) nonreversible), 02 (auxiliary frequency input via O and OI terminals) (reversible), 03 (disabling O2 terminal)	03	×	×
	A011	[O]-[L] input active range start frequency	0.00 to 99.99, 100.0 to 400.0 (Hz)	0.00	×	○
	A012	[O]-[L] input active range end frequency	0.00 to 99.99, 100.0 to 400.0 (Hz)	0.00	×	○
	A013	[O]-[L] input active range start voltage	0. to "[O]-[L] input active range end voltage" (%)	0.	×	○
	A014	[O]-[L] input active range end voltage	"[O]-[L] input active range start voltage" to 100. (%)	100.	×	○
	A015	[O]-[L] input active range start frequency selection	00 (external start frequency), 01 (0 Hz)	01	×	○
	A016	External frequency filter time const.	1. to 30. or 31. (500 ms filter ±0.1 Hz with hysteresis)	31.	×	○
A017	Easy sequence function selection	00 (disabling), 01 (enabling)	00	×	×	
Multispeed operation and jogging	A019	Multispeed operation selection	00 (binary: 16 speeds selectable with 4 terminals), 01 (bit: 8 speeds selectable with 7 terminals)	00	×	×
	A020	Multispeed frequency setting	0.0 or "start frequency" to "maximum frequency" (Hz)	0.00	○	○
	A220	Multispeed frequency setting, 2nd motor	0.0 or "start frequency" to "maximum frequency, 2nd motor" (Hz)	0.00	○	○
	A320	Multispeed frequency setting, 3rd motor	0.0 or "start frequency" to "maximum frequency, 3rd motor" (Hz)	0.00	○	○
	A021	Multispeed 1 setting	0.0 or "start frequency" to "1st maximum frequency" (Hz)	0.00	○	○
	A022	Multispeed 2 setting	0.0 or "start frequency" to "2nd maximum frequency" (Hz)	0.00	○	○
	A023	Multispeed 3 setting	0.0 or "start frequency" to "3rd maximum frequency" (Hz)	0.00	○	○
	A024	Multispeed 4 setting	0.0 or "start frequency" to "n-th maximum frequency" (Hz)	0.00	○	○
	A025	Multispeed 5 setting	0.0 or "start frequency" to "n-th maximum frequency" (Hz)	0.00	○	○
	A026	Multispeed 6 setting	0.0 or "start frequency" to "n-th maximum frequency" (Hz)	0.00	○	○
	A027	Multispeed 7 setting	0.0 or "start frequency" to "n-th maximum frequency" (Hz)	0.00	○	○
	A028	Multispeed 8 setting	0.0 or "start frequency" to "n-th maximum frequency" (Hz)	0.00	○	○
	A029	Multispeed 9 setting	0.0 or "start frequency" to "n-th maximum frequency" (Hz)	0.00	○	○
	A030	Multispeed 10 setting	0.0 or "start frequency" to "n-th maximum frequency" (Hz)	0.00	○	○
	A031	Multispeed 11 setting	0.0 or "start frequency" to "n-th maximum frequency" (Hz)	0.00	○	○
	A032	Multispeed 12 setting	0.0 or "start frequency" to "n-th maximum frequency" (Hz)	0.00	○	○
	A033	Multispeed 13 setting	0.0 or "start frequency" to "n-th maximum frequency" (Hz)	0.00	○	○
	A034	Multispeed 14 setting	0.0 or "start frequency" to "n-th maximum frequency" (Hz)	0.00	○	○
	A035	Multispeed 15 setting	0.0 or "start frequency" to "n-th maximum frequency" (Hz)	0.00	○	○
	A038	Jog frequency setting	"Start frequency" to 9.99 (Hz)	1.00	○	○
	A039	Jog stop mode	00 (free-running after jogging stops [disabled during operation]), 01 (deceleration and stop after jogging stops [disabled during operation]), 02 (DC braking after jogging stops [disabled during operation]), 03 (free-running after jogging stops [enabled during operation]), 04 (deceleration and stop after jogging stops [enabled during operation]), 05 (DC braking after jogging stops [enabled during operation])	00	×	○

*1 This setting is valid only when the OPE-SR is connected.

Chapter 4 List of Data Settings

Code	Function name	Monitored data or setting	Default	Setting during operation (allowed or not)	Change during operation (allowed or not)	
			_FF			
V/f characteristic	A041	Torque boost method selection	00 (manual torque boost), 01 (automatic torque boost)	00	×	×
	A241	Torque boost method selection, 2nd motor	00 (manual torque boost), 01 (automatic torque boost)	00	×	×
	A042	Manual torque boost value	0.0 to 20.0 (%)	1.0	○	○
	A242	Manual torque boost value, 2nd motor	0.0 to 20.0 (%)	1.0	○	○
	A342	Manual torque boost value, 3rd motor	0.0 to 20.0 (%)	1.0	○	○
	A043	Manual torque boost frequency adjustment	0.0 to 50.0 (%)	5.0	○	○
	A243	Manual torque boost frequency adjustment, 2nd motor	0.0 to 50.0 (%)	5.0	○	○
	A343	Manual torque boost frequency adjustment, 3rd motor	0.0 to 50.0 (%)	5.0	○	○
	A044	V/F characteristic curve selection, 1st motor	00 (VC), 01 (VP), 02 (free V/f), 03 (sensorless vector control)	00	×	×
	A244	V/F characteristic curve selection, 2nd motor	00 (VC), 01 (VP), 02 (free V/f), 03 (sensorless vector control)	00	×	×
	A344	V/F characteristic curve selection, 3rd motor	00(VC), 01(VP)	00	×	×
	A045	V/f gain setting	20. to 100. (%)	100.	○	○
	A046	Voltage compensation gain setting for automatic torque boost, 1st motor	0. to 255.	100.	○	○
	A246	Voltage compensation gain setting for automatic torque boost, 2nd motor	0. to 255.	100.	○	○
	A047	Slippage compensation gain setting for automatic torque boost, 1st motor	0. to 255.	100.	○	○
A247	Slippage compensation gain setting for automatic torque boost, 2nd motor	0. to 255.	100.	○	○	
DC braking	A051	DC braking enable	00 (disabling), 01 (enabling), 02 (set frequency only)	00	×	○
	A052	DC braking frequency setting	0.00 to 99.99, 100.0 to 400.0 (Hz)	0.50	×	○
	A053	DC braking wait time	0.0 to 5.0 (s)	0.0	×	○
	A054	DC braking force during deceleration	0. to 70. (%) <0. to 50. (%)>	20.	×	○
	A055	DC braking time for deceleration	0.0 to 60.0 (s)	0.5	×	○
	A056	DC braking/edge or level detection for [DB] input	00 (edge operation), 01 (level operation)	01	×	○
	A057	DC braking force for starting	0. to 70.(%) <0. to 50. (%)>	0.	×	○
	A058	DC braking time for starting	0.0 to 60.0(s)	0.0	×	○
	A059	DC braking carrier frequency setting	0.5 to 12.0(kHz) <0.5 to 8.0 (kHz) >	3.0	×	×
Frequency upper/lower limit and jump	A061	Frequency upper limit setting	0.00 or "1st minimum frequency limit" to "maximum frequency" (Hz)	0.00	×	○
	A261	Frequency upper limit setting, 2nd motor	0.00 or "2nd minimum frequency limit" to "maximum frequency, 2nd motor" (Hz)	0.00	×	○
	A062	Frequency lower limit setting	0.00 or "start frequency" to "maximum frequency limit" (Hz)	0.00	×	○
	A262	Frequency lower limit setting, 2nd motor	0.00 or "start frequency" to "maximum frequency, 2nd motor limit" (Hz)	0.00	×	○
	A063	Jump (center) frequency setting 1	0.00 to 99.99, 100.0 to 400.0 (Hz)	0.00	×	○
	A064	Jump (hysteresis) frequency width setting 1	0.00 to 10.00 (Hz)	0.50	×	○
	A065	Jump (center) frequency setting 2	0.00 to 99.99, 100.0 to 400.0 (Hz)	0.00	×	○
	A066	Jump (hysteresis) frequency width setting 2	0.00 to 10.00 (Hz)	0.50	×	○
	A067	Jump (center) frequency setting 3	0.00 to 99.99, 100.0 to 400.0 (Hz)	0.00	×	○
	A068	Jump (hysteresis) frequency width setting 3	0.00 to 10.00 (Hz)	0.50	×	○
	A069	Acceleration stop frequency setting	0.00 to 99.99, 100.0 to 400.0 (Hz)	0.00	×	○
A070	Acceleration stop time frequency setting	0.0 to 60.0 (s)	0.0	×	○	
PID control	A071	PID Function Enable	00 (disabling), 01 (enabling), 02 (enabling inverted-data output)	00	×	○
	A072	PID proportional gain	0.2 to 5.0	1.0	○	○
	A073	PID integral time constant	0.0 to 999.9, 1000. to 3600. (s)	1.0	○	○
	A074	PID derivative gain	0.00 to 99.99, 100.0 (s)	0.00	○	○
	A075	PV scale conversion	0.01 to 99.99	1.00	×	○
	A076	PV source setting	00 (input via OI), 01 (input via O), 02 (external communication), 03 (pulse-string frequency input), 10 (operation result output)	00	×	○
	A077	Output of inverted PID deviation	00(OFF), 01 (ON)	00	×	○
	A078	PID variation range	0.0 to 100.0 (%)	0.00	×	○
	A079	PID feed forward selection	00 (disabled), 01 (O input), 02 (OI input), 03 (O2 input)	00	×	○

(Note)<->indicate the setting range of 90 to 160kW

Chapter 4 List of Data Settings

Code	Function name	Monitored data or setting	Default	Setting during operation (allowed or not)	Change during operation (allowed or not)	
			_FF			
AVR	A081	AVR function select	00 (always on), 01 (always off), 02 (off during deceleration)	02	×	×
	A082	AVR voltage select	200 V class: 200, 215, 220, 230, 240 (V) 400 V class: 380, 400, 415, 440, 460, 480 (V)	200/400	×	×
Operation mode and acceleration/deceleration function	A085	Operation mode selection	00 (normal operation), 01 (energy-saving operation)	00	×	×
	A086	Energy saving mode tuning	0.1 to 100.0	50.0	○	○
	A092	Acceleration (2) time setting	0.01 to 99.99, 100.0 to 999.9, 1000. to 3600. (s)	15.00	○	○
	A292	Acceleration (2) time setting, 2nd motor	0.01 to 99.99, 100.0 to 999.9, 1000. to 3600. (s)	15.00	○	○
	A392	Acceleration (2) time setting, 3rd motor	0.01 to 99.99, 100.0 to 999.9, 1000. to 3600. (s)	15.00	○	○
	A093	Deceleration (2) time setting	0.01 to 99.99, 100.0 to 999.9, 1000. to 3600. (s)	15.00	○	○
	A293	Deceleration (2) time setting, 2nd motor	0.01 to 99.99, 100.0 to 999.9, 1000. to 3600. (s)	15.00	○	○
	A393	Deceleration (2) time setting, 3rd motor	0.01 to 99.99, 100.0 to 999.9, 1000. to 3600. (s)	15.00	○	○
	A094	Select method to switch to Acc2/Dec2 profile	00 (switching by 2CH terminal), 01 (switching by setting), 02 (switching only when rotation is reversed)	00	×	×
	A294	Select method to switch to Acc2/Dec2, 2nd motor	00 (switching by 2CH terminal), 01 (switching by setting), 02 (switching only when rotation is reversed)	00	×	×
	A095	Acc1 to Acc2 frequency transition point	0.00 to 99.99, 100.0 to 400.0 (Hz)	0.00	×	×
	A295	Acc1 to Acc2 frequency transition point, 2nd motor	0.00 to 99.99, 100.0 to 400.0 (Hz)	0.00	×	×
	A096	Dec1 to Dec2 frequency transition point	0.00 to 99.99, 100.0 to 400.0 (Hz)	0.00	×	×
	A296	Dec1 to Dec2 frequency transition point, 2nd motor	0.00 to 99.99, 100.0 to 400.0 (Hz)	0.00	×	×
	A097	Acceleration curve selection	00 (linear), 01 (S curve), 02 (U curve), 03 (inverted-U curve), 04 (EL-S curve)	00	×	×
	A098	Deceleration curve setting	00 (linear), 01 (S curve), 02 (U curve), 03 (inverted-U curve), 04 (EL-S curve)	00	×	×
External frequency adjustment	A101	[O1]-[L] input active range start frequency	0.00 to 99.99, 100.0 to 400.0 (Hz)	0.00	×	○
	A102	[O1]-[L] input active range end frequency	0.00 to 99.99, 100.0 to 400.0 (Hz)	0.00	×	○
	A103	[O1]-[L] input active range start current	0. to "[O1]-[L] input active range end current" (%)	20.	×	○
	A104	[O1]-[L] input active range end current	"[O1]-[L] input active range start current" to 100. (%)	100.	×	○
	A105	[O1]-[L] input start frequency enable	00 (external start frequency), 01 (0 Hz)	00	×	○
	A111	[O2]-[L] input active range start frequency	-400. to -100., -99.9 to 0.00 to 99.99, 100.0 to 400.0 (Hz)	0.00	×	○
	A112	[O2]-[L] input active range end frequency	-400. to -100., -99.9 to 0.00 to 99.99, 100.0 to 400.0 (Hz)	0.00	×	○
	A113	[O2]-[L] input active range start voltage	-100. to 02 end-frequency rate (%)	-100.	×	○
A114	[O2]-[L] input active range end voltage	"02 start-frequency rate" to 100. (%)	100.	×	○	
Acceleration and deceleration	A131	Acceleration curve constants setting	01 (smallest swelling) to 10 (largest swelling)	02	×	○
	A132	Deceleration curve constants setting	01 (smallest swelling) to 10 (largest swelling)	02	×	○
Operation-target frequency	A141	Operation-target frequency selection 1	00 (digital operator), 01 (keypad potentiometer), 02 (input via O), 03 (input via OI), 04 (external communication), 05 (option 1), 06 (option 2), 07 (pulse-string frequency input)	02	×	○
	A142	Operation-target frequency selection 2	00 (digital operator), 01 (keypad potentiometer), 02 (input via O), 03 (input via OI), 04 (external communication), 05 (option 1), 06 (option 2), 07 (pulse-string frequency input)	03	×	○
	A143	Operator selection	00 (addition: A141 + A142), 01 (subtraction: A141 - A142), 02 (multiplication: A141 x A142)	00	×	○
	A145	Frequency to be added	0.00 to 99.99, 100.0 to 400.0 (Hz)	0.00	×	○
	A146	Sign of the frequency to be added	00 (frequency command + A145), 01 (frequency command - A145)	00	×	○
Acceleration and deceleration	A150	EL-S-curve acceleration ratio 1	0. to 50. (%)	25.	×	×
	A151	EL-S-curve acceleration ratio 2	0. to 50. (%)	25.	×	×
	A152	EL-S-curve deceleration ratio 1	0. to 50. (%)	25.	×	×
	A153	EL-S-curve deceleration ratio 2	0. to 50. (%)	25.	×	×

*1 This setting is valid only when the OPE-SR is connected.

Chapter 4 List of Data Settings

Code	Function name	Monitored data or setting	Default	Setting during operation (allowed or not)	Change during operation (allowed or not)	
			_FF			
Restart after instantaneous power failure or tripping	b001	Selection of restart mode	00 (tripping), 01 (starting with 0 Hz), 02 (starting with matching frequency), 03 (tripping after deceleration and stopping with matching frequency), 04 (restarting with active matching frequency)	00	×	○
	b002	Allowable under-voltage power failure time	0.3 to 25.0 (s)	1.0	×	○
	b003	Retry wait time before motor restart	0.3 to 100.0 (s)	1.0	×	○
	b004	Instantaneous power failure/under-voltage trip alarm enable	00 (disabling), 01 (enabling), 02 (disabling during stopping and decelerating to stop)	00	×	○
	b005	Number of restarts on power failure/under-voltage trip events	00 (16 times), 01 (unlimited)	00	×	○
	b006	Phase loss detection enable	00 (disabling), 01 (enabling)	00	×	○
	b007	Restart frequency threshold	0.00 to 99.99, 100.0 to 400.0 (Hz)	0.00	×	○
	b008	Selection of retry after tripping	00 (tripping), 01 (starting with 0 Hz), 02 (starting with matching frequency), 03 (tripping after deceleration and stopping with matching frequency), 04 (restarting with active matching frequency)	00	×	○
	b009	Selection of retry after undervoltage	00 (16 times), 01 (unlimited)	00	×	○
	b010	Selection of retry count after overvoltage or overcurrent	1 to 3 (times)	3	×	○
	b011	Retry wait time after tripping	0.3 to 100.0 (s)	1.0	×	○
Electronic thermal function	b012	Electronic thermal setting (calculated within the inverter from current output)	0.20 x "rated current" to 1.00 x "rated current" (A)	Rated current of inverter	×	○
	b212	Electronic thermal setting (calculated within the inverter from current output), 2nd motor	0.20 x "rated current" to 1.00 x "rated current" (A)	Rated current of inverter	×	○
	b312	Electronic thermal setting (calculated within the inverter from current output), 3rd motor	0.20 x "rated current" to 1.00 x "rated current" (A)	Rated current of inverter	×	○
	b013	Electronic thermal characteristic	00 (reduced-torque characteristic), 01 (constant-torque characteristic), 02 (free setting)	01	×	○
	b213	Electronic thermal characteristic, 2nd motor	00 (reduced-torque characteristic), 01 (constant-torque characteristic), 02 (free setting)	01	×	○
	b313	Electronic thermal characteristic, 3rd motor	00 (reduced-torque characteristic), 01 (constant-torque characteristic), 02 (free setting)	01	×	○
	b015	Free setting, electronic thermal frequency (1)	0. to 400. (Hz)	0.	×	○
	b016	Free setting, electronic thermal current (1)	0.0 to rated current (A)	0.0	×	○
	b017	Free setting, electronic thermal frequency (2)	0. to 400. (Hz)	0.	×	○
	b018	Free setting, electronic thermal current (2)	0.0 to rated current (A)	0.0	×	○
	b019	Free setting, electronic thermal frequency (3)	0. to 400. (Hz)	0.	×	○
b020	Free setting, electronic thermal current (3)	0.0 to rated current (A)	0.0	×	○	
Overload restriction and overcurrent restraint	b021	Overload restriction operation mode	00 (disabling), 01 (enabling during acceleration and deceleration), 02 (enabling during constant speed), 03 (enabling during acceleration and deceleration (increasing the speed during regeneration))	01	×	○
	b022	Overload restriction setting	0.20 x "rated current" to 1.50 x "rated current" (A) <0.20 x "rated current" to 1.50 x "rated current" (A)>	Rated current of inverter x 1.20	×	○
	b023	Deceleration rate at overload restriction	0.10 to 30.00 (s)	1.00	×	○
	b024	Overload restriction operation mode (2)	00 (disabling), 01 (enabling during acceleration and deceleration), 02 (enabling during constant speed), 03 (enabling during acceleration and deceleration (increasing the speed during regeneration))	01	×	○
	b025	Overload restriction setting (2)	0.20 x "rated current" to 1.50 x "rated current" (A) <0.20 x "rated current" to 1.50 x "rated current" (A)>	Rated current of inverter x 1.20	×	○
	b026	Deceleration rate at overload restriction (2)	0.10 to 30.00 (s)	1.00	×	○
	b027	Overcurrent suppression enable	00 (disabling), 01 (enabling)	01	×	○
	b028	Active frequency matching, scan start frequency	0.20 x "rated current" to 1.50 x "rated current" (A) <0.20 x "rated current" to 1.50 x "rated current" (A)>	Rated current of inverter	×	○
	b029	Active frequency matching, scan-time constant	0.10 to 30.00 (s)	0.50	×	○
	b030	Active frequency matching, restart frequency select	00 (frequency at the last shutoff), 01 (maximum frequency), 02 (set frequency)	00	×	○
Software lock	b031	Software lock mode selection	00 (disabling change of data other than "b031" when SFT is on), 01 (disabling change of data other than "b031" and frequency settings when SFT is on), 02 (disabling change of data other than "b031"), 03 (disabling change of data other than "b031" and frequency settings), 10 (enabling data changes during operation)	01	×	○

(Note)<>indicate the setting range of 90 to 160kW

Chapter 4 List of Data Settings

Code	Function name	Monitored data or setting	Default	Setting during operation (allowed or not)	Change during operation (allowed or not)	
			_FF			
Others	b034	Run/power-on warning time	0. to 9999. (0 to 99990), 1000 to 6553 (100000 to 655300) (hr)	0.	×	○
	b035	Rotational direction restriction	00 (enabling both forward and reverse rotations), 01 (enabling only forward rotation), 02 (enabling only reverse rotation)	00	×	×
	b036	Reduced voltage start selection	0 (minimum reduced voltage start time) to 255 (maximum reduced voltage start time)	6	×	○
	b037	Function code display restriction	00 (full display), 01 (function-specific display), 02 (user setting), 03 (data comparison display), 04 (basic display)	04	×	○
	b038	Initial-screen selection	00 (screen displayed when the STR key was pressed last), 01 (d001), 02 (d002), 03 (d003), 04 (d007), 05 (F001)	01	×	○
	b039	Automatic user-parameter setting function enable	00 (disabling), 01 (enabling)	00	×	○
Torque limitation	b040	Torque limit selection	00 (quadrant-specific setting), 01 (switching by terminal), 02 (analog input), 03 (option 1), 04 (option 2)	00	×	○
	b041	Torque limit (1) (forward-driving in 4-quadrant mode)	0. to 150. (%), no (disabling torque limitation)	120.	×	○
	b042	Torque limit (2) (reverse-regenerating in 4-quadrant mode)	0. to 150. (%), no (disabling torque limitation)	120.	×	○
	b043	Torque limit (3) (reverse-driving in 4-quadrant mode)	0. to 150. (%), no (disabling torque limitation)	120.	×	○
	b044	Torque limit (4) (forward-regenerating in 4-quadrant mode)	0. to 150. (%), no (disabling torque limitation)	120.	×	○
	b045	Torque limit LADSTOP enable	00 (disabling), 01 (enabling)	00	×	○
	b046	Reverse Run protection enable	00 (disabling), 01 (enabling)	01	×	○
Non-stop operation at momentary power failure	b050	Controller deceleration and stop on power loss	00 (disabling), 01 (nonstop deceleration to stop), 02 (DC voltage constant control, with resume), 03 (without resume)	00	×	×
	b051	DC bus voltage trigger level during power loss	0.0 to 999.9, 1000. (V)	220.0/ 440.0	×	×
	b052	Over-voltage threshold during power loss	0.0 to 999.9, 1000. (V)	360.0/ 720.0	×	×
	b053	Deceleration time setting during power loss	0.01 to 99.99, 100.0 to 999.9, 1000. to 3600. (s)	1.00	×	×
	b054	Initial output frequency decrease during power loss	0.00 to 10.00 (Hz)	0.00	×	×
	b055	Proportional gain setting for nonstop operation at power loss	0.00 to 2.55	0.20	○	○
	b056	Integral time setting for nonstop operation at power loss	0.000 to 9.999 / 10.00 to 65.53 (s)	0.100	○	○
Window comparator	b060	Maximum-limit level of window comparators O	0. to 100. (lower limit : b061 + b062 * 2) (%)	100	○	○
	b061	Minimum-limit level of window comparators O	0. to 100. (lower limit : b060 - b062 * 2) (%)	0	○	○
	b062	Hysteresis width of window comparators O	0. to 10. (lower limit : b061 - b062 / 2) (%)	0	○	○
	b063	Maximum-limit level of window comparators OI	0. to 100. (lower limit : b064 + b066 * 2) (%)	100	○	○
	b064	Minimum-limit level of window comparators OI	0. to 100. (lower limit : b063 - b066 * 2) (%)	0	○	○
	b065	Hysteresis width of window comparators OI	0. to 10. (lower limit : b063 - b064 / 2) (%)	0	○	○
	b066	Maximum-limit level of window comparators OI	-100. to 100. (lower limit : b067 + b068 * 2) (%)	100	○	○
	b067	Minimum-limit level of window comparators O/OI/O2	-100. to 100. (lower limit : b066 - b068 * 2) (%)	-100	○	○
	b068	Hysteresis width of window comparators O/OI/O2	0. to 10. (lower limit : b066 - b067 / 2) (%)	0	○	○
	b070	Operation level at O disconnection	0. to 100. (%) or "no" (ignore)	no	×	○
	b071	Operation level at OI disconnection	0. to 100. (%) or "no" (ignore)	no	×	○
b072	Operation level at O2 disconnection	-100. to 100. (%) or "no" (ignore)	no	×	○	

(Note) <> indicate the setting range of 90 to 160kW

Chapter 4 List of Data Settings

Code	Function name	Monitored data or setting	Default	Setting during operation (allowed or not)	Change during operation (allowed or not)	
			_FF			
Others	b078	Cumulative input power data clearance	Clearance by setting "01" and pressing the STR key	00	○	○
	b079	Cumulative input power display gain setting	1. to 1000.	1.	○	○
	b082	Start frequency adjustment	0.10 to 9.99 (Hz)	0.50	×	○
	b083	Carrier frequency setting	0.5 to 12.0 (kHz) (subject to derating) <0.5 to 12.0 (kHz) (subject to derating)>	3.0	×	×
	b084	Initialization mode (parameters or trip history)	00 (clearing the trip history), 01 (initializing the data), 02 (clearing the trip history and initializing the data)	00	×	×
	b086	Frequency scaling conversion factor	0.1 to 99.0	1.0	○	○
	b087	STOP key enable	00 (enabling), 01 (disabling), 02 (disabling only the function to stop)	00	×	○
	b088	Restart mode after FRS	00 (starting with 0 Hz), 01 (starting with matching frequency), 02 (starting with active matching frequency)	00	×	○
	b089	Automatic carrier frequency reduction	00: invalid, 01: valid	00	×	×
	b090	Dynamic braking usage ratio	0.0 to 100.0 (%)	0.0	×	○
	b091	Stop mode selection	00 (deceleration until stop), 01 (free-run stop)	00	×	○
	b092	Cooling fan control	00 (always operating the fan), 01 (operating the fan only during inverter operation [including 5 minutes after power-on and power-off])	01	×	○
	b095	Dynamic braking control	00 (disabling), 01 (enabling [disabling while the motor is topped]), 02 (enabling [enabling also while the motor is topped])	01	×	○
	b096	Dynamic braking activation level	330 to 380, 660 to 760(V)	360/ 720	×	○
	b098	Thermistor for thermal protection control	00 (disabling the thermistor), 01 (enabling the thermistor with PTC), 02 (enabling the thermistor with NTC)	00	×	○
b099	Thermal protection level setting	0. to 9999. (Ω)	3000.	×	○	
Free setting of V/f characteristic	b100	Free-setting V/f frequency (1)	0. to "free-setting V/f frequency (2)" (Hz)	0.	×	×
	b101	Free-setting V/f voltage (1)	0.0 to 800.0 (V)	0.0	×	×
	b102	Free-setting V/f frequency (2)	0. to "free-setting V/f frequency (3)" (Hz)	0.	×	×
	b103	Free-setting V/f voltage (2)	0.0 to 800.0 (V)	0.0	×	×
	b104	Free-setting V/f frequency (3)	0. to "free-setting V/f frequency (4)" (Hz)	0.	×	×
	b105	Free-setting V/f voltage (3)	0.0 to 800.0 (V)	0.0	×	×
	b106	Free-setting V/f frequency (4)	0. to "free-setting V/f frequency (5)" (Hz)	0.	×	×
	b107	Free-setting V/f voltage (4)	0.0 to 800.0 (V)	0.0	×	×
	b108	Free-setting V/f frequency (5)	0. to "free-setting V/f frequency (6)" (Hz)	0.	×	×
	b109	Free-setting V/f voltage (5)	0.0 to 800.0 (V)	0.0	×	×
	b110	Free-setting V/f frequency (6)	0. to "free-setting V/f frequency (7)" (Hz)	0.	×	×
	b111	Free-setting V/f voltage (6)	0.0 to 800.0 (V)	0.0	×	×
	b112	Free-setting V/f frequency (7)	0. to 400. (Hz)	0.	×	×
	b113	Free-setting V/f voltage (7)	0.0 to 800.0 (V)	0.0	×	×
Others	b130	Overvoltage suppression enable	00 (disabling the restraint), 01 (controlled deceleration), 02 (enabling acceleration)	00	×	○
	b131	Overvoltage suppression level	330 to 390 (V) (200 V class model), 660 to 780 (V) (400 V class model)	380/ 760	×	○
	b132	Acceleration and deceleration rate at overvoltage suppression	0.10 to 30.00 (s)	1.00	×	○
	b133	Overvoltage suppression proportional gain	0.00 to 2.55	0.50	○	○
	b134	Overvoltage suppression Integral time	0.000 to 9.999 / 10.00 to 65.53 (s)	0.060	○	○

(Note)<>indicate the setting range of 90 to 160kW

Chapter 4 List of Data Settings

Code	Function name	Monitored data or setting	Default	Setting during operation (allowed or not)	Change during operation (allowed or not)	
			_FF			
Intelligent input terminals	C001	Terminal [1] function (*2)	01 (RV: Reverse RUN), 02 (CF1: Multispeed 1 setting), 03 (CF2: Multispeed 2 setting), 04 (CF3: Multispeed 3 setting), 05 (CF4: Multispeed 4 setting), 06 (JG: Jogging), 07 (DB: external DC braking), 08 (SET: Set 2nd motor data), 09 (2CH: 2-stage acceleration/deceleration), 11 (FRS: free-run stop), 12 (EXT: external trip), 13 (USP: unattended start protection), 14: (CS: commercial power source enable), 15 (SFT: software lock), 16 (AT: analog input voltage/current select), 17 (SET3: 3rd motor control), 18 (RS: reset), 20 (STA: starting by 3-wire input), 21 (STP: stopping by 3-wire input), 22 (F/R: forward/reverse switching by 3-wire input), 23 (PID: PID disable), 24 (PIDC: PID reset), 26 (CAS: control gain setting), 27 (UP: remote control UP function), 28 (DWN: remote control DOWN function), 29 (DWN: remote control data clearing), 31 (OPE: forcible operation), 32 (SF1: multispeed bit 1), 33 (SF2: multispeed bit 2), 34 (SF3: multispeed bit 3), 35 (SF4: multispeed bit 4), 36 (SF5: multispeed bit 5), 37 (SF6: multispeed bit 6), 38 (SF7: multispeed bit 7), 39 (OLR: overload restriction selection), 40 (TL: torque limit enable), 41 (TRQ1: torque limit selection bit 1), 42 (TRQ2: torque limit selection bit 2), 43 (PPI: P/PI mode selection), 46 (LAC: LAD cancellation), 50 (ADD: trigger for frequency addition [A145]), 51 (F-TM: forcible-terminal operation), 53 (KHC: cumulative power clearance), 56 (MI1: general-purpose input 1), 57 (MI2: general-purpose input 2), 58 (MI3: general-purpose input 3), 59 (MI4: general-purpose input 4), 60 (MI5: general-purpose input 5), 61 (MI6: general-purpose input 6), 62 (MI7: general-purpose input 7), 63 (MI8: general-purpose input 8), 64(EMR: Emergency stop signal), 65 (AHD: analog command holding), 74 (PCNT: pulse counter), 75 (PCC: pulse counter clear), no (NO: no assignment)	18 (*2)	×	○
	C002	Terminal [2] function	16	×	○	
	C003	Terminal [3] function (*2)	03 (*2)	×	○	
	C004	Terminal [4] function	02	×	○	
	C005	Terminal [5] function	01	×	○	
	C006	Terminal [6] function	06	×	○	
	C007	Terminal [7] function	11	×	○	
	C008	Terminal [8] function	13	×	○	
	C011	Terminal [1] active state	00 (NO) / 01 (NC)	00	×	○
	C012	Terminal [2] active state	00 (NO) / 01 (NC)	00	×	○
	C013	Terminal [3] active state	00 (NO) / 01 (NC)	00	×	○
	C014	Terminal [4] active state	00 (NO) / 01 (NC)	00	×	○
	C015	Terminal [5] active state	00 (NO) / 01 (NC)	00	×	○
	C016	Terminal [6] active state	00 (NO) / 01 (NC)	00	×	○
	C017	Terminal [7] active state	00 (NO) / 01 (NC)	00	×	○
	C018	Terminal [8] active state	00 (NO) / 01 (NC)	00	×	○
	C019	Terminal [FW] active state	00 (NO) / 01 (NC)	00	×	○

*2 When the emergency stop function is enabled (SW1 = ON), "18" (RS) and "64" (EMR) are forcibly written to parameters "C001" and "C003", respectively. (You cannot arbitrarily write "64" to "C001".) If the SW1 signal is turned off and then turned on, "no" (no assignment) is set in parameter "C003".

Code	Function name	Monitored data or setting	Default	Setting during operation (allowed or not)	Change during operation (allowed or not)	
			_FF			
Intelligent output terminals	C021	Terminal [11] function	00 (RUN: running), 01 (FA1: constant-speed reached), 02 (FA2: set frequency overreached), 03 (OL: overload notice advance signal (1)), 04 (OD: output deviation for PID control), 05 (AL: alarm signal), 06 (FA3: set frequency reached), 07 (OTQ: over-torque), 08 (IP: instantaneous power failure), 09 (UV: undervoltage), 10 (TRQ: torque limited), 11 (RNT: operation time over), 12 (ONT: plug-in time over), 13 (THM: thermal alarm signal), 21 (ZS: 0 Hz detection signal), 24 (FA4: set frequency overreached 2), 25 (FA5: set frequency reached 2), 26 (OL2: overload notice advance signal (2)), 27 (Odc: Analog O disconnection detection), 28 (OIDc: Analog OI disconnection detection), 29 (O2Dc: Analog O2 disconnection detection), 31 (FBV: PID feedback comparison), 32 (NDc: communication line disconnection), 33 (LOG1: logical operation result 1), 34 (LOG2: logical operation result 2), 35 (LOG3: logical operation result 3), 36 (LOG4: logical operation result 4), 37 (LOG5: logical operation result 5), 38 (LOG6: logical operation result 6), 39 (WAC: capacitor life warning), 40 (WAF: cooling-fan speed drop), 41 (FR: starting contact signal), 42 (OHF: heat sink overheat warning), 43 (LOC: low-current indication signal), 44 (M01: general-purpose output 1), 45 (M02: general-purpose output 2), 46 (M03: general-purpose output 3), 47 (M04: general-purpose output 4), 48 (M05: general-purpose output 5), 49 (M06: general-purpose output 6), 50 (IRDY: inverter ready), 51 (FWR: forward rotation), 52 (RVR: reverse rotation), 53 (MJA: major failure), 54(WCO: window comparator O), 55(WCOI: window comparator OI), 56 (WCO2: window comparator O2) (When alarm code output is selected for "C062", functions "AC0" to "AC2" or "AC0" to "AC3" [ACn: alarm code output] are forcibly assigned to intelligent output terminals 11 to 13 or 11 to 14, respectively.)	01	×	×
	C022	Terminal [12] function	00 (RUN: running), 01 (FA1: constant-speed reached), 02 (FA2: set frequency overreached), 03 (OL: overload notice advance signal (1)), 04 (OD: output deviation for PID control), 05 (AL: alarm signal), 06 (FA3: set frequency reached), 07 (OTQ: over-torque), 08 (IP: instantaneous power failure), 09 (UV: undervoltage), 10 (TRQ: torque limited), 11 (RNT: operation time over), 12 (ONT: plug-in time over), 13 (THM: thermal alarm signal), 21 (ZS: 0 Hz detection signal), 24 (FA4: set frequency overreached 2), 25 (FA5: set frequency reached 2), 26 (OL2: overload notice advance signal (2)), 27 (Odc: Analog O disconnection detection), 28 (OIDc: Analog OI disconnection detection), 29 (O2Dc: Analog O2 disconnection detection), 31 (FBV: PID feedback comparison), 32 (NDc: communication line disconnection), 33 (LOG1: logical operation result 1), 34 (LOG2: logical operation result 2), 35 (LOG3: logical operation result 3), 36 (LOG4: logical operation result 4), 37 (LOG5: logical operation result 5), 38 (LOG6: logical operation result 6), 39 (WAC: capacitor life warning), 40 (WAF: cooling-fan speed drop), 41 (FR: starting contact signal), 42 (OHF: heat sink overheat warning), 43 (LOC: low-current indication signal), 44 (M01: general-purpose output 1), 45 (M02: general-purpose output 2), 46 (M03: general-purpose output 3), 47 (M04: general-purpose output 4), 48 (M05: general-purpose output 5), 49 (M06: general-purpose output 6), 50 (IRDY: inverter ready), 51 (FWR: forward rotation), 52 (RVR: reverse rotation), 53 (MJA: major failure), 54(WCO: window comparator O), 55(WCOI: window comparator OI), 56 (WCO2: window comparator O2) (When alarm code output is selected for "C062", functions "AC0" to "AC2" or "AC0" to "AC3" [ACn: alarm code output] are forcibly assigned to intelligent output terminals 11 to 13 or 11 to 14, respectively.)	00	×	×
	C023	Terminal [13] function	00 (RUN: running), 01 (FA1: constant-speed reached), 02 (FA2: set frequency overreached), 03 (OL: overload notice advance signal (1)), 04 (OD: output deviation for PID control), 05 (AL: alarm signal), 06 (FA3: set frequency reached), 07 (OTQ: over-torque), 08 (IP: instantaneous power failure), 09 (UV: undervoltage), 10 (TRQ: torque limited), 11 (RNT: operation time over), 12 (ONT: plug-in time over), 13 (THM: thermal alarm signal), 21 (ZS: 0 Hz detection signal), 24 (FA4: set frequency overreached 2), 25 (FA5: set frequency reached 2), 26 (OL2: overload notice advance signal (2)), 27 (Odc: Analog O disconnection detection), 28 (OIDc: Analog OI disconnection detection), 29 (O2Dc: Analog O2 disconnection detection), 31 (FBV: PID feedback comparison), 32 (NDc: communication line disconnection), 33 (LOG1: logical operation result 1), 34 (LOG2: logical operation result 2), 35 (LOG3: logical operation result 3), 36 (LOG4: logical operation result 4), 37 (LOG5: logical operation result 5), 38 (LOG6: logical operation result 6), 39 (WAC: capacitor life warning), 40 (WAF: cooling-fan speed drop), 41 (FR: starting contact signal), 42 (OHF: heat sink overheat warning), 43 (LOC: low-current indication signal), 44 (M01: general-purpose output 1), 45 (M02: general-purpose output 2), 46 (M03: general-purpose output 3), 47 (M04: general-purpose output 4), 48 (M05: general-purpose output 5), 49 (M06: general-purpose output 6), 50 (IRDY: inverter ready), 51 (FWR: forward rotation), 52 (RVR: reverse rotation), 53 (MJA: major failure), 54(WCO: window comparator O), 55(WCOI: window comparator OI), 56 (WCO2: window comparator O2) (When alarm code output is selected for "C062", functions "AC0" to "AC2" or "AC0" to "AC3" [ACn: alarm code output] are forcibly assigned to intelligent output terminals 11 to 13 or 11 to 14, respectively.)	03	×	×
	C024	Terminal [14] function	00 (RUN: running), 01 (FA1: constant-speed reached), 02 (FA2: set frequency overreached), 03 (OL: overload notice advance signal (1)), 04 (OD: output deviation for PID control), 05 (AL: alarm signal), 06 (FA3: set frequency reached), 07 (OTQ: over-torque), 08 (IP: instantaneous power failure), 09 (UV: undervoltage), 10 (TRQ: torque limited), 11 (RNT: operation time over), 12 (ONT: plug-in time over), 13 (THM: thermal alarm signal), 21 (ZS: 0 Hz detection signal), 24 (FA4: set frequency overreached 2), 25 (FA5: set frequency reached 2), 26 (OL2: overload notice advance signal (2)), 27 (Odc: Analog O disconnection detection), 28 (OIDc: Analog OI disconnection detection), 29 (O2Dc: Analog O2 disconnection detection), 31 (FBV: PID feedback comparison), 32 (NDc: communication line disconnection), 33 (LOG1: logical operation result 1), 34 (LOG2: logical operation result 2), 35 (LOG3: logical operation result 3), 36 (LOG4: logical operation result 4), 37 (LOG5: logical operation result 5), 38 (LOG6: logical operation result 6), 39 (WAC: capacitor life warning), 40 (WAF: cooling-fan speed drop), 41 (FR: starting contact signal), 42 (OHF: heat sink overheat warning), 43 (LOC: low-current indication signal), 44 (M01: general-purpose output 1), 45 (M02: general-purpose output 2), 46 (M03: general-purpose output 3), 47 (M04: general-purpose output 4), 48 (M05: general-purpose output 5), 49 (M06: general-purpose output 6), 50 (IRDY: inverter ready), 51 (FWR: forward rotation), 52 (RVR: reverse rotation), 53 (MJA: major failure), 54(WCO: window comparator O), 55(WCOI: window comparator OI), 56 (WCO2: window comparator O2) (When alarm code output is selected for "C062", functions "AC0" to "AC2" or "AC0" to "AC3" [ACn: alarm code output] are forcibly assigned to intelligent output terminals 11 to 13 or 11 to 14, respectively.)	07	×	×
	C025	Terminal [15] function	00 (RUN: running), 01 (FA1: constant-speed reached), 02 (FA2: set frequency overreached), 03 (OL: overload notice advance signal (1)), 04 (OD: output deviation for PID control), 05 (AL: alarm signal), 06 (FA3: set frequency reached), 07 (OTQ: over-torque), 08 (IP: instantaneous power failure), 09 (UV: undervoltage), 10 (TRQ: torque limited), 11 (RNT: operation time over), 12 (ONT: plug-in time over), 13 (THM: thermal alarm signal), 21 (ZS: 0 Hz detection signal), 24 (FA4: set frequency overreached 2), 25 (FA5: set frequency reached 2), 26 (OL2: overload notice advance signal (2)), 27 (Odc: Analog O disconnection detection), 28 (OIDc: Analog OI disconnection detection), 29 (O2Dc: Analog O2 disconnection detection), 31 (FBV: PID feedback comparison), 32 (NDc: communication line disconnection), 33 (LOG1: logical operation result 1), 34 (LOG2: logical operation result 2), 35 (LOG3: logical operation result 3), 36 (LOG4: logical operation result 4), 37 (LOG5: logical operation result 5), 38 (LOG6: logical operation result 6), 39 (WAC: capacitor life warning), 40 (WAF: cooling-fan speed drop), 41 (FR: starting contact signal), 42 (OHF: heat sink overheat warning), 43 (LOC: low-current indication signal), 44 (M01: general-purpose output 1), 45 (M02: general-purpose output 2), 46 (M03: general-purpose output 3), 47 (M04: general-purpose output 4), 48 (M05: general-purpose output 5), 49 (M06: general-purpose output 6), 50 (IRDY: inverter ready), 51 (FWR: forward rotation), 52 (RVR: reverse rotation), 53 (MJA: major failure), 54(WCO: window comparator O), 55(WCOI: window comparator OI), 56 (WCO2: window comparator O2) (When alarm code output is selected for "C062", functions "AC0" to "AC2" or "AC0" to "AC3" [ACn: alarm code output] are forcibly assigned to intelligent output terminals 11 to 13 or 11 to 14, respectively.)	40	×	×
	C026	Alarm relay terminal function	00 (RUN: running), 01 (FA1: constant-speed reached), 02 (FA2: set frequency overreached), 03 (OL: overload notice advance signal (1)), 04 (OD: output deviation for PID control), 05 (AL: alarm signal), 06 (FA3: set frequency reached), 07 (OTQ: over-torque), 08 (IP: instantaneous power failure), 09 (UV: undervoltage), 10 (TRQ: torque limited), 11 (RNT: operation time over), 12 (ONT: plug-in time over), 13 (THM: thermal alarm signal), 21 (ZS: 0 Hz detection signal), 24 (FA4: set frequency overreached 2), 25 (FA5: set frequency reached 2), 26 (OL2: overload notice advance signal (2)), 27 (Odc: Analog O disconnection detection), 28 (OIDc: Analog OI disconnection detection), 29 (O2Dc: Analog O2 disconnection detection), 31 (FBV: PID feedback comparison), 32 (NDc: communication line disconnection), 33 (LOG1: logical operation result 1), 34 (LOG2: logical operation result 2), 35 (LOG3: logical operation result 3), 36 (LOG4: logical operation result 4), 37 (LOG5: logical operation result 5), 38 (LOG6: logical operation result 6), 39 (WAC: capacitor life warning), 40 (WAF: cooling-fan speed drop), 41 (FR: starting contact signal), 42 (OHF: heat sink overheat warning), 43 (LOC: low-current indication signal), 44 (M01: general-purpose output 1), 45 (M02: general-purpose output 2), 46 (M03: general-purpose output 3), 47 (M04: general-purpose output 4), 48 (M05: general-purpose output 5), 49 (M06: general-purpose output 6), 50 (IRDY: inverter ready), 51 (FWR: forward rotation), 52 (RVR: reverse rotation), 53 (MJA: major failure), 54(WCO: window comparator O), 55(WCOI: window comparator OI), 56 (WCO2: window comparator O2) (When alarm code output is selected for "C062", functions "AC0" to "AC2" or "AC0" to "AC3" [ACn: alarm code output] are forcibly assigned to intelligent output terminals 11 to 13 or 11 to 14, respectively.)	05	×	×
Analog monitoring	C027	[FM] signal selection	00 (output frequency), 01 (output current), 02 (output torque), 03 (digital output frequency), 04 (output voltage), 05 (input power), 06 (electronic thermal overload), 07 (LAD frequency), 08 (digital current monitoring), 09 (motor temperature), 10 (heat sink temperature), 12 (general-purpose output YA0)	00	×	×
	C028	[AM] signal selection	00 (output frequency), 01 (output current), 02 (output torque), 04 (output voltage), 05 (input power), 06 (electronic thermal overload), 07 (LAD frequency), 09 (motor temperature), 10 (heat sink temperature), 11 (output torque [signed value]), 13 (general-purpose output YA1)	00	×	×
	C029	[AMI] signal selection	00 (output frequency), 01 (output current), 02 (output torque), 04 (output voltage), 05 (input power), 06 (electronic thermal overload), 07 (LAD frequency), 09 (motor temperature), 10 (heat sink temperature), 14 (general-purpose output YA2)	00	×	×
	C030	Digital current monitor reference value	0.20 x "rated current" to 1.50 x "rated current" (A) (Current with digital current monitor output at 1,440 Hz)	Rated current of inverter	○	○
Intelligent output terminals	C031	Terminal [11] active state	00 (NO) / 01 (NC)	00	×	×
	C032	Terminal [12] active state	00 (NO) / 01 (NC)	00	×	×
	C033	Terminal [13] active state	00 (NO) / 01 (NC)	00	×	×
	C034	Terminal [14] active state	00 (NO) / 01 (NC)	00	×	×
	C035	Terminal [15] active state	00 (NO) / 01 (NC)	00	×	×
	C036	Alarm relay active state	00 (NO) / 01 (NC)	01	×	×

Chapter 4 List of Data Settings

Code	Function name	Monitored data or setting	Default	Setting during operation (allowed or not)	Change during operation (allowed or not)	
			_FF			
Levels and output terminal status	C038	Low-current indication signal output mode selection	00 (output during acceleration/deceleration and constant-speed operation), 01 (output only during constant-speed operation)	01	×	○
	C039	Low-current indication signal detection level	0.0 to 1.50 x "rated current" (A)	Rated current of inverter	○	○
	C040	Overload signal output mode	00 (output during acceleration/deceleration and constant-speed operation), 01 (output only during constant-speed operation)	01	×	○
	C041	Overload level setting	0.0 to 1.50 x "rated current" (A) <0.0 to 1.50 x "rated current">	Rated current of inverter	○	○
	C042	Frequency arrival setting for accel.	0.00 to 99.99, 100.0 to 400.0 (Hz)	0.00	×	○
	C043	Frequency arrival setting for decel.	0.00 to 99.99, 100.0 to 400.0 (Hz)	0.00	×	○
	C044	PID deviation level setting	0.0 to 100.0 (%)	3.0	×	○
	C045	Frequency arrival setting for acceleration (2)	0.00 to 99.99, 100.0 to 400.0 (Hz)	0.00	×	○
	C046	Frequency arrival setting for deceleration (2)	0.00 to 99.99, 100.0 to 400.0 (Hz)	0.00	×	○
	C052	Maximum PID feedback data	0.0 to 100.0 (%)	100.0	×	○
	C053	Minimum PID feedback data	0.0 to 100.0 (%)	0.0	×	○
	C055	Over-torque (forward-driving) level setting	0. to 150. (%)	100.	×	○
	C056	Over-torque (reverse regenerating) level setting	0. to 150. (%)	100.	×	○
	C057	Over-torque (reverse driving) level setting	0. to 150. (%)	100.	×	○
	C058	Over-torque (forward regenerating) level setting	0. to 150. (%)	100.	×	○
	C061	Electronic thermal warning level setting	0. to 100. (%)	80.	×	○
C062	Alarm code output	00 (disabling), 01 (3 bits), 02 (4 bits)	00	×	○	
C063	Zero speed detection level	0.00 to 99.99, 100.0 (Hz)	0.00	×	○	
C064	Heat sink overheat warning level	0. to 200.0 (°C)	120.	×	○	
Communication function	C071	Communication speed selection	02 (loopback test), 03 (2,400 bps), 04 (4,800 bps), 05 (9,600 bps), 06 (19,200 bps)	04	×	○
	C072	Node allocation	1. to 32.	1.	×	○
	C073	Communication data length selection	7 (7 bits), 8 (8 bits)	7	×	○
	C074	Communication parity selection	00 (no parity), 01 (even parity), 02 (odd parity)	00	×	○
	C075	Communication stop bit selection	1 (1 bit), 2 (2 bits)	1	×	○
	C076	Selection of the operation after communication error	00 (tripping), 01 (tripping after decelerating and stopping the motor), 02 (ignoring errors), 03 (stopping the motor after free-running), 04 (decelerating and stopping the motor)	02	×	○
	C077	Communication timeout limit before tripping	0.00 to 99.99 (s)	0.00	×	○
	C078	Communication wait time	0. to 1000. (ms)	0.	×	○
	C079	Communication mode selection	00(ASCII), 01(Modbus-RTU)	00	×	○
Adjustment	C081	[O] input span calibration	0. to 9999., 1000 to 6553(10000 to 65530)	Factory setting	○	○
	C082	[OI] input span calibration	0. to 9999., 1000 to 6553(10000 to 65530)	Factory setting	○	○
	C083	[O2] input span calibration	0. to 9999., 1000 to 6553(10000 to 65530)	Factory setting	○	○
	C085	Thermistor input tuning	0.0 to 999.9, 1000.	Factory setting	○	○
	C091	Debug mode enable	(Do not change this parameter, which is intended for factory adjustment.)	00	×	×
Others	C101	Up/Down memory mode selection	00 (not storing the frequency data), 01 (storing the frequency data)	00	×	○
	C102	Reset mode selection	00 (resetting the trip when RS is on), 01 (resetting the trip when RS is off), 02 (enabling resetting only upon tripping [resetting when RS is on]), 03(resetting only trip)	00	○	○
	C103	Restart mode after reset	00 (starting with 0 Hz), 01 (starting with matching frequency), 02 (restarting with active matching frequency)	00	×	○
Meter adjustment	C105	FM gain adjustment	50. to 200. (%)	100.	○	○
	C106	AM gain adjustment	50. to 200. (%)	100.	○	○
	C107	AMI gain adjustment	50. to 200. (%)	100.	○	○
	C109	AM bias adjustment	0. to 100. (%)	0.	○	○
	C110	AMI bias adjustment	0. to 100. (%)	20.	○	○

(Note)<->indicate the setting range of 90 to 160kW

Chapter 4 List of Data Settings

Code		Function name	Monitored data or setting	Default	Setting during operation (allowed or not)	Change during operation (allowed or not)	
				_FF			
Terminal	C111	Overload setting (2)	0.0 to 1.50 x "rated current" (A) <0.0 to 1.50 x "rated current" (A)>	Rated current of inverter	○	○	
Adjustment	C121	[O] input zero calibration	0. to 9999., 1000 to 6553 (10000 to 65530)	Factory setting	○	○	
	C122	[OL] input zero calibration	0. to 9999., 1000 to 6553 (10000 to 65530)	Factory setting	○	○	
	C123	[O2] input zero calibration	0. to 9999., 1000 to 6553 (10000 to 65530)	Factory setting	○	○	
Output terminal operation function	C130	Output 11 on-delay time	0.0 to 100.0 (s)	0.0	×	○	
	C131	Output 11 off-delay time	0.0 to 100.0 (s)	0.0	×	○	
	C132	Output 12 on-delay time	0.0 to 100.0 (s)	0.0	×	○	
	C133	Output 12 off-delay time	0.0 to 100.0 (s)	0.0	×	○	
	C134	Output 13 on-delay time	0.0 to 100.0 (s)	0.0	×	○	
	C135	Output 13 off-delay time	0.0 to 100.0 (s)	0.0	×	○	
	C136	Output 14 on-delay time	0.0 to 100.0 (s)	0.0	×	○	
	C137	Output 14 off-delay time	0.0 to 100.0 (s)	0.0	×	○	
	C138	Output 15 on-delay time	0.0 to 100.0 (s)	0.0	×	○	
	C139	Output 15 off-delay time	0.0 to 100.0 (s)	0.0	×	○	
	C140	Output RY on-delay time	0.0 to 100.0 (s)	0.0	×	○	
	C141	Output RY off-delay time	0.0 to 100.0 (s)	0.0	×	○	
	C142	Logical output signal 1 selection 1	Same as the settings of C021 to C026 (except those of LOG1 to LOG6)	00	×	○	
	C143	Logical output signal 1 selection 2	Same as the settings of C021 to C026 (except those of LOG1 to LOG6)	00	×	○	
	C144	Logical output signal 1 operator selection	00 (AND), 01 (OR), 02 (XOR)	00	×	○	
	C145	Logical output signal 2 selection 1	Same as the settings of C021 to C026 (except those of LOG1 to LOG6)	00	×	○	
	C146	Logical output signal 2 selection 2	Same as the settings of C021 to C026 (except those of LOG1 to LOG6)	00	×	○	
	C147	Logical output signal 2 operator selection	00 (AND), 01 (OR), 02 (XOR)	00	×	○	
	C148	Logical output signal 3 selection 1	Same as the settings of C021 to C026 (except those of LOG1 to LOG6)	00	×	○	
	C149	Logical output signal 3 selection 2	Same as the settings of C021 to C026 (except those of LOG1 to LOG6)	00	×	○	
	C150	Logical output signal 3 operator selection	00 (AND), 01 (OR), 02 (XOR)	00	×	○	
	C151	Logical output signal 4 selection 1	Same as the settings of C021 to C026 (except those of LOG1 to LOG6)	00	×	○	
	C152	Logical output signal 4 selection 2	Same as the settings of C021 to C026 (except those of LOG1 to LOG6)	00	×	○	
	C153	Logical output signal 4 operator selection	00 (AND), 01 (OR), 02 (XOR)	00	×	○	
	C154	Logical output signal 5 selection 1	Same as the settings of C021 to C026 (except those of LOG1 to LOG6)	00	×	○	
	C155	Logical output signal 5 selection 2	Same as the settings of C021 to C026 (except those of LOG1 to LOG6)	00	×	○	
	C156	Logical output signal 5 operator selection	00 (AND), 01 (OR), 02 (XOR)	00	×	○	
	C157	Logical output signal 6 selection 1	Same as the settings of C021 to C026 (except those of LOG1 to LOG6)	00	×	○	
	C158	Logical output signal 6 selection 2	Same as the settings of C021 to C026 (except those of LOG1 to LOG6)	00	×	○	
	C159	Logical output signal 6 operator selection	00 (AND), 01 (OR), 02 (XOR)	00	×	○	
	Input terminal response	C160	Input terminal response time setting 1	0. to 200. (× 2ms)	1	×	○
		C161	Input terminal response time setting 2	0. to 200. (× 2ms)	1	×	○
		C162	Input terminal response time setting 3	0. to 200. (× 2ms)	1	×	○
C163		Input terminal response time setting 4	0. to 200. (× 2ms)	1	×	○	
C164		Input terminal response time setting 5	0. to 200. (× 2ms)	1	×	○	
C165		Input terminal response time setting 6	0. to 200. (× 2ms)	1	×	○	
C166		Input terminal response time setting 7	0. to 200. (× 2ms)	1	×	○	
C167		Input terminal response time setting 8	0. to 200. (× 2ms)	1	×	○	
C168		Input terminal response time setting FW	0. to 200. (× 2ms)	1	×	○	
Other	C169	Multistage speed/position determination time	0. to 200. (× 10ms)	0	×	○	

(Note)<>indicate the setting range of 90 to 160kW

Chapter 4 List of Data Settings

Code	Function name	Monitored data or setting	Default	Setting during operation (allowed or not)	Change during operation (allowed or not)	
			_FF			
Control constants	H001	Auto-tuning Setting	00 (disabling auto-tuning), 01 (auto-tuning without rotation), 02 (auto-tuning with rotation)	00	×	×
	H002	Motor data selection, 1st motor	00 (Hitachi standard data), 01 (auto-tuned data), 02 (auto-tuned data [with online auto-tuning function])	00	×	×
	H202	Motor data selection, 2nd motor	00 (Hitachi standard data), 01 (auto-tuned data), 02 (auto-tuned data [with online auto-tuning function])	00	×	×
	H003	Motor capacity, 1st motor	0.20 to 90.00 (kW) <0.20 to 160. (kW) >	Factory setting	×	×
	H203	Motor capacity, 2nd motor	0.20 to 90.00 (kW) <0.20 to 160. (kW) >	Factory setting	×	×
	H004	Motor poles setting, 1st motor	2, 4, 6, 8, 10 (poles)	4	×	×
	H204	Motor poles setting, 2nd motor	2, 4, 6, 8, 10 (poles)	4	×	×
	H005	Motor speed constant, 1st motor	0.001 to 9.999, 10.00 to 80.00 (10.000 to 80.000)	1.590	○	○
	H205	Motor speed constant, 2nd motor	0.001 to 9.999, 10.00 to 80.00 (10.000 to 80.000)	1.590	○	○
	H006	Motor stabilization constant, 1st motor	0. to 255.	100.	○	○
	H206	Motor stabilization constant, 2nd motor	0. to 255.	100.	○	○
	H306	Motor stabilization constant, 3rd motor	0. to 255.	100.	○	○
	H020	Motor constant R1, 1st motor	0.001 to 9.999, 10.00 to 65.53 (Ω)	Depending on motor capacity	×	×
	H220	Motor constant R1, 2nd motor	0.001 to 9.999, 10.00 to 65.53 (Ω)	Depending on motor capacity	×	×
	H021	Motor constant R2, 1st motor	0.001 to 9.999, 10.00 to 65.53 (Ω)	Depending on motor capacity	×	×
	H221	Motor constant R2, 2nd motor	0.001 to 9.999, 10.00 to 65.53 (Ω)	Depending on motor capacity	×	×
	H022	Motor constant L, 1st motor	0.01 to 99.99, 100.0 to 655.3 (mH)	Depending on motor capacity	×	×
	H222	Motor constant L, 2nd motor	0.01 to 99.99, 100.0 to 655.3 (mH)	Depending on motor capacity	×	×
	H023	Motor constant I _o	0.01 to 99.99, 100.0 to 655.3 (A)	Depending on motor capacity	×	×
	H223	Motor constant I _o , 2nd motor	0.01 to 99.99, 100.0 to 655.3 (A)	Depending on motor capacity	×	×
	H024	Motor constant J	0.001 to 9.999, 10.00 to 99.99, 100.0 to 999.9, 1000. to 9999.	Depending on motor capacity	×	×
	H224	Motor constant J, 2nd motor	0.001 to 9.999, 10.00 to 99.99, 100.0 to 999.9, 1000. to 9999.	Depending on motor capacity	×	×
	H030	Auto constant R1, 1st motor	0.001 to 9.999, 10.00 to 65.53 (Ω)	Depending on motor capacity	×	×
	H230	Auto constant R1, 2nd motor	0.001 to 9.999, 10.00 to 65.53 (Ω)	Depending on motor capacity	×	×
	H031	Auto constant R2, 1st motor	0.001 to 9.999, 10.00 to 65.53 (Ω)	Depending on motor capacity	×	×
	H231	Auto constant R2, 2nd motor	0.001 to 9.999, 10.00 to 65.53 (Ω)	Depending on motor capacity	×	×
	H032	Auto constant L, 1st motor	0.01 to 99.99, 100.0 to 655.3 (mH)	Depending on motor capacity	×	×
	H232	Auto constant L, 2nd motor	0.01 to 99.99, 100.0 to 655.3 (mH)	Depending on motor capacity	×	×
	H033	Auto constant I _o , 1st motor	0.01 to 99.99, 100.0 to 655.3 (A)	Depending on motor capacity	×	×
	H233	Auto constant I _o , 2nd motor	0.01 to 99.99, 100.0 to 655.3 (A)	Depending on motor capacity	×	×
	H034	Auto constant J, 1st motor	0.001 to 9.999, 10.00 to 99.99, 100.0 to 999.9, 1000. to 9999.	Depending on motor capacity	×	×
	H234	Auto constant J, 2nd motor	0.001 to 9.999, 10.00 to 99.99, 100.0 to 999.9, 1000. to 9999.	Depending on motor capacity	×	×
	H050	PI proportional gain for 1st motor	0.0 to 999.9, 1000.	100.0	○	○
	H250	PI proportional gain for 2nd motor	0.0 to 999.9, 1000.	100.0	○	○
	H051	PI integral gain for 1st motor	0.0 to 999.9, 1000.	100.0	○	○
	H251	PI integral gain for 2nd motor	0.0 to 999.9, 1000.	100.0	○	○
	H052	P proportional gain setting for 1st motor	0.01 to 10.00	1.00	○	○
	H252	P proportional gain setting for 2nd motor	0.01 to 10.00	1.00	○	○
	H070	Terminal selection PI proportional gain setting	0.0 to 999.9, 1000.	100.0	○	○
	H071	Terminal selection PI integral gain setting	0.0 to 999.9, 1000.	100.0	○	○
H072	Terminal selection P proportional gain setting	0.00 to 10.00	1.00	○	○	
H073	Gain switching time	0. to 9999. (ms)	100.	○	○	

(Note)<>indicate the setting range of 90 to 160kW

Chapter 4 List of Data Settings

Code	Function name	Monitored data or setting	Default	Setting during operation (allowed or not)	Change during operation (allowed or not)	
			_FF			
Optional functions	P001	Operation mode on expansion card 1 error	00 (tripping), 01 (continuing operation)	00	×	○
	P002	Operation mode on expansion card 2 error	00 (tripping), 01 (continuing operation)	00	×	○
	P025	Temperature compensation thermistor enable	00 (no compensation), 01 (compensation)	00	×	○
	P031	Accel/decel time input selection	00 (digital operator), 01 (option 1), 02 (option 2), 03 (easy sequence)	00	×	×
	P044	DeviceNet comm watchdog timer	0.00 to 99.99 (s)	1.00	×	×
	P045	Inverter action on DeviceNet comm error	00 (tripping), 01 (tripping after decelerating and stopping the motor), 02 (ignoring errors), 03 (stopping the motor after free-running), 04 (decelerating and stopping the motor)	01	×	×
	P046	DeviceNet polled I/O: Output instance number	20, 21, 100	21	×	×
	P047	DeviceNet polled I/O: Input instance number	70, 71, 101	71	×	×
	P048	Inverter action on DeviceNet idle mode	00 (tripping), 01 (tripping after decelerating and stopping the motor), 02 (ignoring errors), 03 (stopping the motor after free-running), 04 (decelerating and stopping the motor)	01	×	×
	P049	DeviceNet motor poles setting for RPM	0, 2, 4, 6, 8, 10, 12, 14, 16, 18, 20, 22, 24, 26, 28, 30, 32, 34, 36, 38 (poles)	0	×	×
	P055	Pulse-string frequency scale	1.0 to 50.0 (kHz)	25.0	×	○
	P056	Time constant of pulse-string frequency filter	0.01 to 2.00 (s)	0.10	×	○
	P057	Pulse-string frequency bias	-100. to +100. (%)	0.	×	○
	P058	Pulse-string frequency limit	0. to 100. (%)	100.	×	○
Easy sequence function	P100	Easy sequence user parameter U (00)	0. to 9999., 1000 to 6553 (10000 to 65535)	0.	○	○
	P101	Easy sequence user parameter U (01)	0. to 9999., 1000 to 6553 (10000 to 65535)	0.	○	○
	P102	Easy sequence user parameter U (02)	0. to 9999., 1000 to 6553 (10000 to 65535)	0.	○	○
	P103	Easy sequence user parameter U (03)	0. to 9999., 1000 to 6553 (10000 to 65535)	0.	○	○
	P104	Easy sequence user parameter U (04)	0. to 9999., 1000 to 6553 (10000 to 65535)	0.	○	○
	P105	Easy sequence user parameter U (05)	0. to 9999., 1000 to 6553 (10000 to 65535)	0.	○	○
	P106	Easy sequence user parameter U (06)	0. to 9999., 1000 to 6553 (10000 to 65535)	0.	○	○
	P107	Easy sequence user parameter U (07)	0. to 9999., 1000 to 6553 (10000 to 65535)	0.	○	○
	P108	Easy sequence user parameter U (08)	0. to 9999., 1000 to 6553 (10000 to 65535)	0.	○	○
	P109	Easy sequence user parameter U (09)	0. to 9999., 1000 to 6553 (10000 to 65535)	0.	○	○
	P110	Easy sequence user parameter U (10)	0. to 9999., 1000 to 6553 (10000 to 65535)	0.	○	○
	P111	Easy sequence user parameter U (11)	0. to 9999., 1000 to 6553 (10000 to 65535)	0.	○	○
	P112	Easy sequence user parameter U (12)	0. to 9999., 1000 to 6553 (10000 to 65535)	0.	○	○
	P113	Easy sequence user parameter U (13)	0. to 9999., 1000 to 6553 (10000 to 65535)	0.	○	○
	P114	Easy sequence user parameter U (14)	0. to 9999., 1000 to 6553 (10000 to 65535)	0.	○	○
	P115	Easy sequence user parameter U (15)	0. to 9999., 1000 to 6553 (10000 to 65535)	0.	○	○
	P116	Easy sequence user parameter U (16)	0. to 9999., 1000 to 6553 (10000 to 65535)	0.	○	○
	P117	Easy sequence user parameter U (17)	0. to 9999., 1000 to 6553 (10000 to 65535)	0.	○	○
	P118	Easy sequence user parameter U (18)	0. to 9999., 1000 to 6553 (10000 to 65535)	0.	○	○
	P119	Easy sequence user parameter U (19)	0. to 9999., 1000 to 6553 (10000 to 65535)	0.	○	○
	P120	Easy sequence user parameter U (20)	0. to 9999., 1000 to 6553 (10000 to 65535)	0.	○	○
	P121	Easy sequence user parameter U (21)	0. to 9999., 1000 to 6553 (10000 to 65535)	0.	○	○
	P122	Easy sequence user parameter U (22)	0. to 9999., 1000 to 6553 (10000 to 65535)	0.	○	○
	P123	Easy sequence user parameter U (23)	0. to 9999., 1000 to 6553 (10000 to 65535)	0.	○	○
	P124	Easy sequence user parameter U (24)	0. to 9999., 1000 to 6553 (10000 to 65535)	0.	○	○
	P125	Easy sequence user parameter U (25)	0. to 9999., 1000 to 6553 (10000 to 65535)	0.	○	○
	P126	Easy sequence user parameter U (26)	0. to 9999., 1000 to 6553 (10000 to 65535)	0.	○	○
	P127	Easy sequence user parameter U (27)	0. to 9999., 1000 to 6553 (10000 to 65535)	0.	○	○
	P128	Easy sequence user parameter U (28)	0. to 9999., 1000 to 6553 (10000 to 65535)	0.	○	○
	P129	Easy sequence user parameter U (29)	0. to 9999., 1000 to 6553 (10000 to 65535)	0.	○	○
	P130	Easy sequence user parameter U (30)	0. to 9999., 1000 to 6553 (10000 to 65535)	0.	○	○
P131	Easy sequence user parameter U (31)	0. to 9999., 1000 to 6553 (10000 to 65535)	0.	○	○	

Chapter 4 List of Data Settings

	Code	Function name	Monitored data or setting	Default	Setting during operation (allowed or not)	Change during operation (allowed or not)
				_FF		
User parameters	U001	User-selected function 1	no/d001 to P131	no	○	○
	U002	User-selected function 2	no/d001 to P131	no	○	○
	U003	User-selected function 3	no/d001 to P131	no	○	○
	U004	User-selected function 4	no/d001 to P131	no	○	○
	U005	User-selected function 5	no/d001 to P131	no	○	○
	U006	User-selected function 6	no/d001 to P131	no	○	○
	U007	User-selected function 7	no/d001 to P131	no	○	○
	U008	User-selected function 8	no/d001 to P131	no	○	○
	U009	User-selected function 9	no/d001 to P131	no	○	○
	U010	User-selected function 10	no/d001 to P131	no	○	○
	U011	User-selected function 11	no/d001 to P131	no	○	○
	U012	User-selected function 12	no/d001 to P131	no	○	○

(Note)<>indicate the setting range of 90 to 160kW

Chapter 5 Error Codes

This chapter describes the error codes of the inverter, error indications by the functions, and troubleshooting methods.

5.1	Error Codes and Troubleshooting	5 - 2
5.2	Warning Codes	5 - 4

Chapter 5 Error Codes

5.1 Error Codes and Troubleshooting

5.1.1 Error Codes









Name	Description	Display on digital operator
Overcurrent protection	If the motor is constrained or suddenly accelerated or decelerated, a high current will flow in the inverter and the inverter may fail. To avoid this problem, the inverter shuts off its output and displays the error code shown on the right when it detects a current higher than a specified level. This protective function uses a DC current detector (CT) to detect overcurrent. When a current as high as about 220% of the inverter's rated output current is detected, the protective circuit operates and the inverter trips.	During constant-speed operation E01
		During deceleration E02
		During acceleration E03
		Others E04
Overload protection (*1)	This protective function monitors the inverter output current, and shuts off the inverter output and displays the error code shown on the right when the internal electronic thermal protection circuit detects a motor overload. If the error occurs, the inverter will trip according to the setting of the electronic thermal function.	E05
Braking resistor overload protection	When the BRD operation rate exceeds the setting of "b090", this protective function shuts off the inverter output and displays the error code shown on the right.	E06
Overvoltage protection	If the DC voltage across the P and N terminals rises too high, an inverter failure may result. To avoid this problem, this protective function shuts off the inverter output and displays the error code shown on the right when the DC voltage across the P and N terminals exceeds a specified level because of an increase in the energy regenerated by the motor or the input voltage (during operation). The inverter will trip if the DC voltage across the P and N terminals exceeds about 400 VDC (in case of the 200 V class models) or about 800 VDC (in case of the 400 V class models).	E07
EEPROM error (*2) (*3)	When an internal-EEPROM is caused by external noise or an abnormal temperature rise, the inverter shuts off its output and displays the error code shown on the right. Note: An EEPROM error may result in a CPU error.	E08









Name	Description	Display on digital operator
Undervoltage	If the inverter input voltage drops, the control circuit of the inverter cannot function normally. Therefore, the inverter shuts off its output when the input voltage falls below a specified level. The inverter will trip if the DC voltage across the P and N terminals exceeds about 175 VDC (in case of the 200 V class models) or about 345 VDC (in case of the 400 V class models).	E09
CT error	If an error occurs in the internal current detector (CT), the inverter will shut off its output and display the error code shown on the right. The inverter will trip when the CT outputs about 0.6 V or more at power-on.	E10
CPU error (*3)	If the internal CPU malfunctions or an error occurs in it, the inverter will shut off its output and display the error code shown on the right. Note: Reading an abnormal data from the EEPROM may result in a CPU error.	E11
External trip	If an error occurs in the external equipment or device connected to the inverter, the inverter will fetch the error signal and shut off its output. (This protective function is enabled when the external trip function is enabled.)	E12
USP error	A USP error is indicated when the inverter power is turned on with an input operation signal remaining in the inverter. (This protective function is enabled when the USP function is enabled.)	E13
Ground-fault protection (*3)	When the inverter power is turned on, this protective function detects the ground fault between the inverter output circuit and the motor to protect the inverter. (This function does not operate when a residual voltage remains in the motor.)	E14
Input overvoltage protection	This protective function determines an error if the input voltage is kept above the specification level for 100 seconds while the inverter is stopped. The inverter will trip if the DC voltage of the main circuit is kept above about 390 VDC (in case of the 200 V class models) or about 780 VDC (in case of the 400 V class models).	E15
Instantaneous power failure protection	If an instantaneous power failure lasts 15 ms or more, the inverter will shut off its output. When the power failure duration is long, the inverter assumes a normal power-off. If a restart mode has been selected and an operation command remains in the inverter, the inverter will restart after the power is recovered.	E16
Temperature error due to low cooling-fan speed	The inverter will display the error code shown on the right if the lowering of cooling-fan speed is detected at the occurrence of the temperature error described below.	E20
Temperature error	If the main circuit temperature rises because of a high ambient temperature or for other reasons, the inverter will shut off its output.	E21

*1 The inverter will not accept any reset command within about 10 seconds after tripping (i.e., after the protective function operates).

*2 The inverter will not accept any reset command after an EEPROM error occurs with error code **E08** displayed. Turn off the inverter power once. If error code "E08" is displayed when the inverter power is turned on subsequently, the internal memory device may have failed or parameters may have not been stored correctly. In such cases, initialize the inverter, and then re-set the parameters.

*3 The inverter will not accept reset commands input via the RS terminal or entered by the STOP/RESET key. Therefore, turn off the inverter power.

Name	Description	Display on digital operator
Gate array communication error	If an error occurs in the communication between the internal CPU and gate array, the inverter will trip.	
Phase loss input protection	When the phase loss input protection has been enabled (b006 = 01), the inverter will trip to avoid damage if a phase loss input is detected. The inverter trips when the phase loss input continues for about 1 second or more.	
Main circuit error (*4)	The inverter will trip if the gate array cannot confirm the on/off state of IGBT because of a malfunction due to noise, short or damage to the main circuit element.	
IGBT error	If instantaneous overcurrent occurs, the main circuit element temperature is abnormal, or the main circuit element drive power drops, the inverter will shut off its output to protect the main circuit element. (After tripping because of this protective function, the inverter cannot retry the operation.)	
Thermistor error	The inverter monitors the resistance of the thermistor (in the motor) connected to the inverter's TH terminal, and will shut off the inverter output if the motor temperature rises.	
Emergency stop (*5)	If the EMR signal (on three terminals) is turned on when the slide switch (SW1) on the logic board is set to ON, the inverter hardware will shut off the inverter output and display the error code shown on the right. Malfunction due to incoming noise, in case EMR terminal is not ON.	
Low-speed overload protection	If overload occurs during the motor operation at a very low speed at 0.2 Hz or less, the electronic thermal protection circuit in the inverter will detect the overload and shut off the inverter output. (2nd electronic thermal control) (Note that a high frequency may be recorded as the error history data.)	
Modbus communication error	If timeout occurs because of line disconnection during the communication in Modbus-RTU mode, the inverter will display the error code shown on the right. (The inverter will trip according to the setting of "C076".)	

Name	Description	Display on digital operator
Option 1 error	The inverter detects errors in the option board mounted in the optional slot 1. For details, refer to the instruction manual for the mounted option board.	
Option 2 error	The inverter detects errors in the option board mounted in the optional slot 1. For details, refer to the instruction manual for the mounted option board.	
Waiting in undervoltage status	If the input voltage falls, the inverter will shut off its output, display the code shown on the right, and wait for the recovery of the input voltage. The inverter will display the same error code also during an instantaneous power failure. (remark) Inverter trips with under voltage when this status continues for 40 seconds.	
Communication error	If a problem occurs in the communication between the digital operator and inverter, the inverter will display the code shown on the right.	
Waiting for retry	When the retry after instantaneous power failure or tripping has been enabled, the inverter displays the code shown on the right while awaiting retry after an instantaneous power failure or tripping.	
Power-off	The inverter displays the code shown on the right when the inverter power is turned off.	
Restricted operation command	When an operation direction has been restricted by the setting of "b035", the inverter will display the error code shown on the right if the operation command specifying the restricted operation direction is input.	
Empty trip history	If the inverter has not tripped before, the inverter displays  .	

*4 The inverter will not accept reset commands input via the RS terminal or entered by the STOP/RESET key. Therefore, turn off the inverter power.

*5 The inverter will not accept the reset command entered from the digital operator. Therefore, reset the inverter by turning on the RS terminal.

5.1.2 Trip conditions monitoring

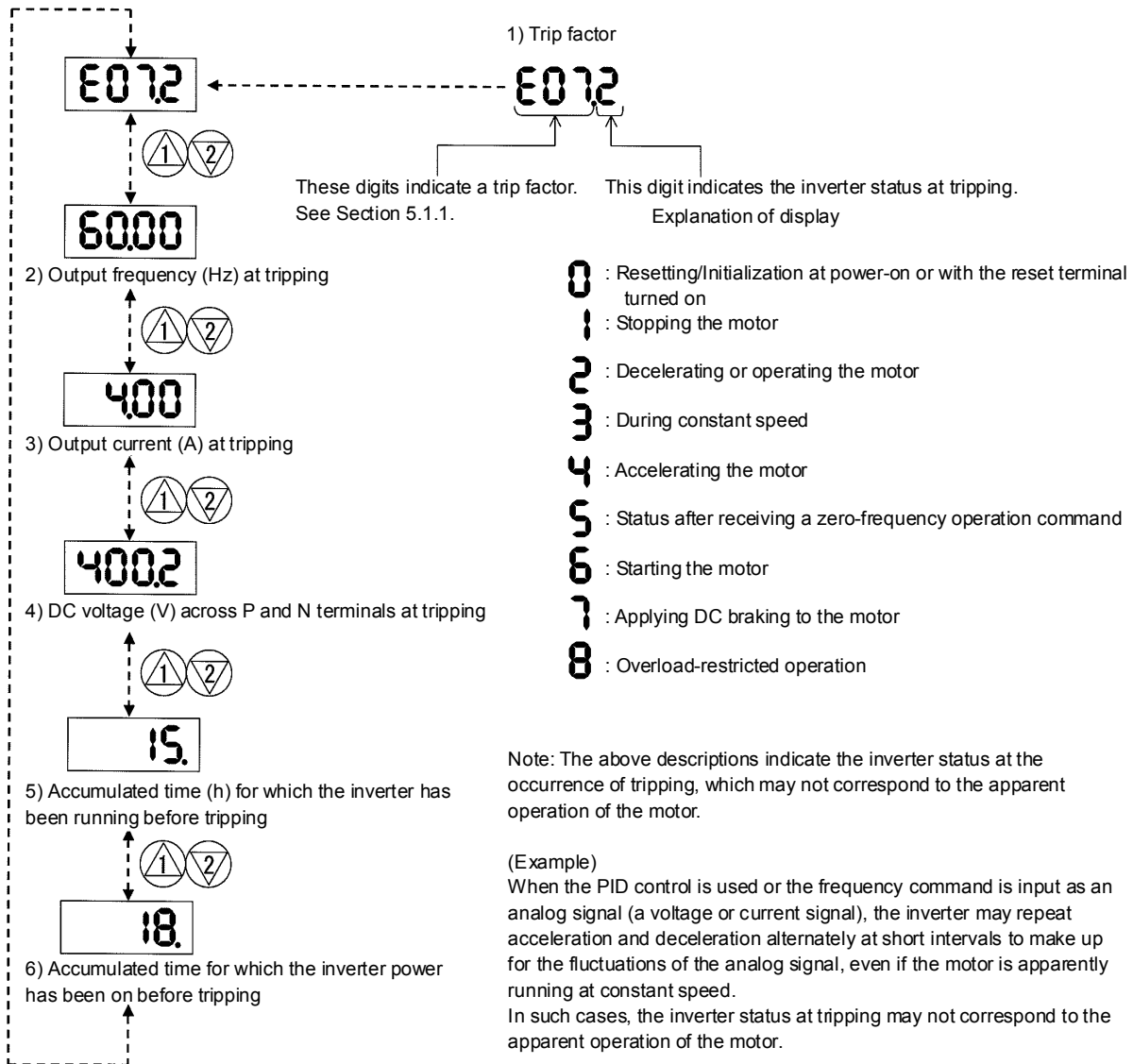

5.2 Warning Codes

The following table lists the warning codes and the contents of parameter readjustments:

Warning code	Target function code	Condition	Basic function code
H001/H201	Frequency upper limit setting (A061/A261)	>	Maximum frequency setting (A004/A204/A304)
H002/H202	Frequency lower limit setting (A062/A262)	>	
H004/H204/H304	Base frequency setting (A003/A203/A303) (*1)	>	
H005/H205/H305	Output frequency setting (F001), multispeed 0 (A202/A220/A320) (*2)	>	
H006/H206/H306	Multispeed 1 to 15 settings (A021 to A035)	>	
H009	Home search speed setting (P015)	>	Frequency upper limit setting (A061/A261)
H012/H212	Frequency lower limit setting (A062/A262)	>	
H015/H215	Output frequency setting (F001), multispeed 0 (A202/A220/A320) (*2)	>	
H016/H216	Multispeed 1 to 15 settings (A021 to A035)	>	Home search speed setting (P015)
H019	Frequency upper limit setting (A061/A261)	<	
H021/H221		<	Frequency lower limit setting (A062/A262)
H025/H225	Output frequency setting (F001), multispeed 0 (A202/A220/A320) (*2)	<	
H031/H231	Frequency upper limit setting (A061/A261)	<	Start frequency adjustment (b082)
H032/H232	Frequency lower limit setting (A062/A262)	<	
H035/H235/H335	Output frequency setting (F001), multispeed 0 (A202/A220/A320) (*2)	<	
H036	Multispeed 1 to 15 settings (A021 to A035)	<	
H037	Jog frequency setting (A038)	<	
H085/H285/H385	Output frequency setting (F001), multispeed 0 (A202/A220/A320) (*2)	<>	Jump (center) frequency settings 1/2/3 ± " Jump (hysteresis) frequency width settings 1/2/3" A063 ± A064, A065 ± A066, A067 ± A068 (*3)
H086	Multispeed 1 to 15 settings (A021 to A035)	<>	
H091/H291	Frequency upper limit setting (A061/A261)	>	Free-setting V/f frequency (7) (b112)
H092/H292	Frequency lower limit setting (A062/A262)	>	
H095/H295	Output frequency setting (F001), multispeed 0 (A202/A220/A320) (*2)	>	
H096	Multispeed 1 to 15 settings (A021 to A035)	>	
H110	Free-setting V/f frequency (1) to (6) (b100, b102, b104, b106, b108, b110)	>	
	Free-setting V/f frequency (2) to (6) (b102, b104, b106, b108, b110)	<	Free-setting V/f frequency (1) (b100)
	Free-setting V/f frequency (1) (b100)	>	Free-setting V/f frequency (2) (b102)
	Free-setting V/f frequency (3) to (6) (b104, b106, b108, b110)	<	Free-setting V/f frequency (3) (b104)
	Free-setting V/f frequency (1) (2) (b100, b102)	>	Free-setting V/f frequency (4) (b104)
	Free-setting V/f frequency (4) to (6) (b106, b108, b110)	<	Free-setting V/f frequency (4) (b106)
	Free-setting V/f frequency (1) to (3) (b100, b102, b104, b110)	>	Free-setting V/f frequency (5) (b108)
	Free-setting V/f frequency (5) (6) (b108, b110)	<	Free-setting V/f frequency (5) (b108)
	Free-setting V/f frequency (1) to (4) (b100, b102, b104, b106)	>	Free-setting V/f frequency (6) (b110)
	Free-setting V/f frequency (6) (b110)	<	Free-setting V/f frequency (6) (b110)
H120	Free setting, electronic thermal frequency (2) (3) (b017/b019)	<	Free setting, electronic thermal frequency (1) (b015)
	Free setting, electronic thermal frequency (1) (b015)	>	Free setting, electronic thermal frequency (2) (b017)
	Free setting, electronic thermal frequency (3) (b019)	<	Free setting, electronic thermal frequency (3) (b019)
	Free setting, electronic thermal frequency (1) (2) (b015/b017)	>	

The inverter displays a warning code when the data set as a target function code satisfies the condition (specified in the Condition column) in relation to the data set as the corresponding basic function code.

Each parameter (target function code) is readjusted to the data set as the basic function code (by updating at the inverter start-up).

- *1 In this case, the base frequency is rewritten at parameter readjustment. If the base frequency is updated to an inappropriate value, a motor burnout may result. Therefore, if the warning is displayed, change the current base frequency data to an appropriate value.
- *2 These parameters are checked, even when the digital operator (02) is not specified for the frequency source setting (A001).
- *3 The current value of the jump (center) frequency is updated to "the current value of the jump frequency" - "value of the Jump (hysteresis) frequency width (minimum)".

(Memo)

Chapter 6 Specifications

This chapter describes the specifications and external dimensions of the inverter.

6.1	Specifications	6-2
6.2	External dimensions	6-5

Chapter 6 Specifications

6.1 Specifications

(1) Specifications of the 200 V class model

Model name (type name) L700-XXXLFF	110	150	185	220	300	370	450	550	750	
Max. applicable motor capacity (4-pole) (kW)	11	15	18.5	22	30	37	45	55	75	
Rated capacity (kVA)	200V	15.2	20.0	26.3	29.4	39.1	49.5	59.2	72.7	93.5
	240V	18.2	24.1	31.5	35.3	46.9	59.4	71	87.2	112.2
Rated input AC voltage	Three-phase (3-wire), 200 to 240 V (+10%, -15%), 50/60 Hz (±5%)									
Rated output voltage	Three-phase (3-wire), 200 to 240 V (corresponding to the input voltage)									
Rated output current (A)	44	58	73	85	113	140	169	210	270	
Braking	Regenerative braking	Internal BRD circuit (external discharge resistor)					External regenerative braking unit			
	Minimum connectable resistance (Ω)	10	10	7.5	7.5	5	-			
Approx. weight (kg)	6	6	14	47	14	22	30	30	43	

(2) Specifications of the 400 V class model

Model name (type name) L700-XXXHFF	110	150	185	220	300	370	450	550	750	900	1100	1320	1600	
Max. applicable motor capacity (4-pole) (kW)	11	15	18.5	22	30	37	45	55	75	90	110	132	160	
Rated capacity (kVA)	400V	15.2	20.9	25.6	30.4	39.4	48.4	58.8	72.7	93.5	110.8	135	159.3	200.9
	480V	18.2	24.1	30.7	36.5	47.3	58.1	70.6	87.2	112.2	133	162.1	191.2	241.1
Rated input AC voltage	Three-phase (3-wire), 380 to 480 V (+10%, -15%), 50/60 Hz (±5%)													
Rated output voltage	Three-phase (3-wire), 380 to 480 V (corresponding to the input voltage)													
Rated output current (A)	22	29	37	43	57	70	85	105	135	160	195	230	290	
Braking	Regenerative braking	Internal BRD circuit (external discharge resistor)					External regenerative braking unit							
	Minimum connectable resistance (Ω)	35	35	24	24	20	-							
Approx. weight (kg)	6	6	14	14	14	22	30	30	30	55	55	70	70	

(3) Common specifications of 200 V class and 400 V class models

Model name (type name) L700-XXXFF	110 L/H	150 L/H	185 L/H	220 L/H	300 L/H	370 L/H	450 L/H	550 L/H	750 L/H	900 H	1100 H	1320 H	1600 H
Protective structure	IP20								IP00				
Control system	Sine-wave PWM control												
Output frequency range	0.1 to 400 Hz (Note 3)												
Frequency accuracy	Within ±0.01% of the maximum output frequency for digital input, within ±0.2% of maximum frequency for digital input (at 25±10°C)												
Frequency setting resolution	Digital input: 0.01 Hz Analog input: Maximum output frequency/4000 (O terminal input: 12 bits/0 to +10 V, O2 terminal input: 12 bits/-10 to +10 V, OI terminal input: 12 bits/0 to +20 mA)												
Voltage/frequency characteristic	V/f characteristic variable with the base frequency set between 30 to 400 Hz, constant- or reduced-torque V/f control, sensorless vector control												
Speed fluctuation	± 0.5% (with sensorless vector control) Note8)												
Rated overload current	120% / 60 seconds												
Acceleration/deceleration time	0.01 to 3,600.0 seconds (in linear or curved pattern)												
Starting torque	150% / 0.5 Hz (with sensorless vector control)								120% / 0.5Hz (do to)				
DC braking	Triggered at motor start-up, when the actual motor frequency exceeds the acceleration frequency set by a stop command, when the actual motor frequency exceeds the frequency set by a frequency command, or by an externally input command (braking force, time, and frequency are variable).												

Chapter 6 Specifications

6.1 Specifications

(1) Specifications of the 200 V class model

Model name (type name) L700-XXXLFF	110	150	185	220	300	370	450	550	750	
Max. applicable motor capacity (4-pole) (kW)	11	15	18.5	22	30	37	45	55	75	
Rated capacity (kVA)	200V	15.2	20.0	26.3	29.4	39.1	49.5	59.2	72.7	93.5
	240V	18.2	24.1	31.5	35.3	46.9	59.4	71	87.2	112.2
Rated input AC voltage	Three-phase (3-wire), 200 to 240 V (+10%, -15%), 50/60 Hz ($\pm 5\%$)									
Rated output voltage	Three-phase (3-wire), 200 to 240 V (corresponding to the input voltage)									
Rated output current (A)	44	58	73	85	113	140	169	210	270	
Braking	Regenerative braking	Internal BRD circuit (external discharge resistor)					External regenerative braking unit			
	Minimum connectable resistance (Ω)	10	10	7.5	7.5	5	-			
Approx. weight (kg)	6	6	14	47	14	22	30	30	43	

(2) Specifications of the 400 V class model

Model name (type name) L700-XXXHFF	110	150	185	220	300	370	450	550	750	900	1100	1320	1600	
Max. applicable motor capacity (4-pole) (kW)	11	15	18.5	22	30	37	45	55	75	90	110	132	160	
Rated capacity (kVA)	400V	15.2	20.9	25.6	30.4	39.4	48.4	58.8	72.7	93.5	110.8	135	159.3	200.9
	480V	18.2	24.1	30.7	36.5	47.3	58.1	70.6	87.2	112.2	133	162.1	191.2	241.1
Rated input AC voltage	Three-phase (3-wire), 380 to 480 V (+10%, -15%), 50/60 Hz ($\pm 5\%$)													
Rated output voltage	Three-phase (3-wire), 380 to 480 V (corresponding to the input voltage)													
Rated output current (A)	22	29	37	43	57	70	85	105	135	160	195	230	290	
Braking	Regenerative braking	Internal BRD circuit (external discharge resistor)					External regenerative braking unit							
	Minimum connectable resistance (Ω)	35	35	24	24	20	-							
Approx. weight (kg)	6	6	14	14	14	22	30	30	30	55	55	70	70	

(3) Common specifications of 200 V class and 400 V class models

Model name (type name) L700-XXXFF	110 L/H	150 L/H	185 L/H	220 L/H	300 L/H	370 L/H	450 L/H	550 L/H	750 L/H	900 H	1100 H	1320 H	1600 H
Protective structure	IP20								IP00				
Control system	Sine-wave PWM control												
Output frequency range	0.1 to 400 Hz												
Frequency accuracy	Within $\pm 0.01\%$ of the maximum output frequency for digital input, within $\pm 0.2\%$ of maximum frequency for digital input (at $25 \pm 10^\circ\text{C}$)												
Frequency setting resolution	Digital input: 0.01 Hz Analog input: Maximum output frequency/4000 (O terminal input: 12 bits/0 to +10 V, O2 terminal input: 12 bits/-10 to +10 V, OI terminal input: 12 bits/0 to +20 mA)												
Voltage/frequency characteristic	V/f characteristic variable with the base frequency set between 30 to 400 Hz, constant- or reduced-torque V/f control, sensorless vector control												
Speed fluctuation	$\pm 0.5\%$ (with sensorless vector control) Note8)												
Rated overload current	120% / 60 seconds												
Acceleration/deceleration time	0.01 to 3,600.0 seconds (in linear or curved pattern)												
Starting torque	150% / 0.5 Hz (with sensorless vector control)								120% / 0.5Hz (do to)				
DC braking	Triggered at motor start-up, when the actual motor frequency exceeds the acceleration frequency set by a stop command, when the actual motor frequency exceeds the frequency set by a frequency command, or by an externally input command (braking force, time, and frequency are variable).												

(3) Common specifications of 200 V class and 400 V class models (continued)

Model name (type name) L700-XXXXF		110 L/H	150 L/H	185 L/H	220 L/H	300 L/H	370 L/H	450 L/H	550 L/H	750 L/H	900 H	1100 H	1320 H	1600 H
Input	Fre- quency setting	Standard operator Setting with  and  keys												
	External signal (Note6)	0 to +10 VDC, -10 to +10 VDC (input impedance: 10kΩ), 4 to 20 mA (input impedance: 100Ω)												
	External port	Setting via RS485 communication												
Input	Start/stop command Forward/reverse command	Standard operator Start/stop commands (forward/reverse switching by parameter setting)												
	External signal	Forward-operation start/stop commands (reverse-operation start/stop possible when relevant commands are assigned to intelligent input terminals) 3-wire input possible (when relevant commands are assigned to control circuit terminals)												
	External port	Setting via RS485 communication												
Input	Intelligent input terminals	8 terminals, NO/NC switchable, sink logic/source logic switchable [Terminal functions] Select eight of 69 functions. Reverse operation (RV), Multispeed 1 setting (CF1), Multispeed 2 setting (CF2), Multispeed 3 setting (CF3), Multispeed 4 setting (CF4), Jogging (JG), external DC braking (DB), 2nd motor control (SET), 2-stage acceleration/deceleration (2CH), free-run stop (FRS), external trip (EXT), unattended start protection (USP), commercial power supply switching (CS), software lock (SFT), analog input switching (AT), 3rd motor control (SET3), reset (RS), starting by 3-wire input (STA), stopping by 3-wire input (STP), forward/reverse switching by 3-wire input (F/R), PID disable (PID), PID integration reset (PIDC), control gain switching (CAS), acceleration by remote control (UP), deceleration by remote control (DWN), data clearance by remote control (UDC), forcible operation (OPE), multispeed bit 1 (SF1), multispeed bit 2 (SF2), multispeed bit 3 (SF3), multispeed bit 4 (SF4), multispeed bit 5 (SF5), multispeed bit 6 (SF6), multispeed bit 7 (SF7), overload restriction selection (OLR), torque limit selection (enabling/disabling) (TL), torque limit 1 (TRQ1), torque limit 2 (TRQ2), P/PI switching (PPI), LAD cancellation (LAC), trigger for frequency addition (A145) (ADD), forcible-terminal operation (F-TM), cumulative power clearance (KHC), general-purpose input 1 (MI1), general-purpose input 2 (MI2), general-purpose input 3 (MI3), general-purpose input 4 (MI4), general-purpose input 5 (MI5), general-purpose input 6 (MI6), general-purpose input 7 (MI7), general-purpose input 8 (MI8), analog command holding (AHD), emergency stop(EMR)*Note4,no assignment (no)												
	Thermistor input terminal	1 terminal (positive temperature coefficient/negative temperature coefficient switchable for resistor)												
Output	Intelligent output terminals	5 open-collector output terminals, NO/NC switchable, sink logic/source logic switchable 1 relay (1c-contact) output terminal: NO/NC switchable [Terminal functions] Select six of 51 functions. Running (RUN), constant-speed reached (FA1), set frequency overreached (FA2), overload notice advance signal (1) (OL), output deviation for PID control (OD), alarm signal (AL), set frequency reached (FA3), over-torque (OTQ), instantaneous power failure (IP), undervoltage (UV), torque limited (TRQ), operation time over (RNT), plug-in time over (ONT), thermal alarm signal (THM), 0 Hz detection signal (ZS), set frequency overreached 2 (FA4), set frequency reached 2 (FA5), overload notice advance signal (2) (OL2), PID feedback comparison (FBV), communication line disconnection (NDc), logical operation result 1 (LOG1), logical operation result 2 (LOG2), logical operation result 3 (LOG3), logical operation result 4 (LOG4), logical operation result 5 (LOG5), logical operation result 6 (LOG6), capacitor life warning (WAC), cooling-fan speed drop (WAF), starting contact signal (FR), heat sink overheat warning (OHF), low-current indication signal (LOC), general-purpose output 1 (M01), general-purpose output 2 (M02), general-purpose output 3 (M03), general-purpose output 4 (M04), general-purpose output 5 (M05), general-purpose output 6 (M06), inverter ready (IRDY), forward rotation (FWR), reverse rotation (RVR), major failure (MJA), alarm code 0 to 3 (AC0 to AC3)												
	Intelligent monitor output terminals	Analog voltage output(Note7), analog current output(Note7), pulse-string output (e.g., A-F, D-F [n-fold, pulse output only], A, T, V, P)												
Monitoring on display		Output frequency Note7), output current Note7), output torque, frequency conversion data, trip history, input/output terminal status, electric power, and others												
Other functions		Free V/f setting (7 breakpoints), frequency upper/lower limit, jump (center) frequency, acceleration/deceleration according to characteristic curve, manual torque boost level/breakpoint, energy-saving operation, analog meter adjustment, start frequency setting, carrier frequency adjustment, electronic thermal function (available also for free setting), external start/end frequency/frequency rate, analog input selection, retry after trip, restart after instantaneous power failure, output of various signals, starting with reduced voltage, overload restriction, initial-value setting, automatic deceleration at power failure, AVR function, fuzzy acceleration/deceleration, online/offline auto-tuning, high-torque multi-motor operation (sensorless vector control of two motors by one inverter)												
Carrier frequency variation		0.5 to 12 kHz									0.5 to 8 kHz			
Protective functions		Overcurrent protection, overvoltage protection, undervoltage protection, electronic thermal protection, temperature error protection, instantaneous power failure protection, phase loss input protection, braking-resistor overload protection, ground-fault current detection at power-on, USP error, external trip, emergency stop trip, CT error, communication error, option board error, and others												

Chapter 6 Specifications

(3) Common specifications of 200 V class and 400 V class models (continued)

Model name (type name)	110	150	185	220	300	370	450	550	750	900	1100	1320	1600
SJ700-XXXXFF2.FEF2,FUF2	L/H	L/H	L/H	L/H	L/H	L/H	L/H	L/H	L/H	H	H	H	H
Operating environment	Ambient temperature, storage temperature(Note5), humidity	-10°C to +40°C (ambient), -20°C to +65°C (storage), 20% to 90% RH (no condensation allowed)											
	Vibration tolerance (See Note 1.)	5.9m/s ² (0.6G),10~55Hz					2.94m/s ² (0.3G),10~55Hz						
	Installation environment	Environment without corrosive gases and dust, at an altitude of 1,000 m or less Note9)											
Coating color		Gray											
Optional boards	Feedback option	Vector control with sensor											
	Digital input option	4-digit BCD input, 16-bit binary input											
	DeviceNet option	Option to support the open-network DeviceNet function											
	LonWorks option	Option to support the open-network LonWorks function											
	Profibus-DP option	Option to support the open-network Profibus-DP function											
Other optional components	Braking resistor, AC reactor, DC reactor, noise filter, operator cables, Harmonic-wave suppressor unit, LCR filter, analog operation panel, regenerative braking unit, controllers for various applications												

Note 1: The vibration tolerance was tested in compliance with JIS C60068-2-6:2010 (IEC 60068-2-6:2007).

Note 2: The insulation distance complies with the UL and CE standards.

Note 3: The applicable motor refers to Hitachi standard 3-phase motor(4-pole).when using other motors,care must be taken to prevent the rated motor current(50/60Hz)from exceeding the rated output current of the inverter.

Note 4: Function "64(EMR)"cannot be assigned to input terminal 3 by an operation from the operator. The function is automatically assigned to the terminal when slide switch SW1 is set to ON.

Note 5: The storage temperature refers to the short-term temperature during transport.

Note 6: The frequency command will equal the maximum frequency at 9.8V for input voltage 0 to 10VDC,or at 19.8mA for input current 4 to 20mA.If this characteristic is not satisfactory for your application, contact your Hitachi sales representative.

Note 7: The analog voltage monitor and the analog current monitor are rough output values for analog meter connection. The maximum output value might shift a little by the difference of the analog output circuit than 10V or 20mA. Please inquire when there is a possibility that the inconvenience is caused.

Note8: As for the range of the speed change, the variation range is different according to the installation situation and the characteristic and the usage condition of the motor. Please inquire about details.

Note9: The density of air decreases by 1% whenever rising by 100m when the altitude exceeds 1000m. Therefore, it is necessary to decrease the calorific value. The calorific value of the main circuit semiconductor such as IGBT is proportional to the current and the voltage. Therefore, please decrease by 1% and use the current rating every time it rises by 100m. Please inquire about use in the high ground of 2500m or more.

6.2 External dimensions

L700-110 to 150 LFF / HFF

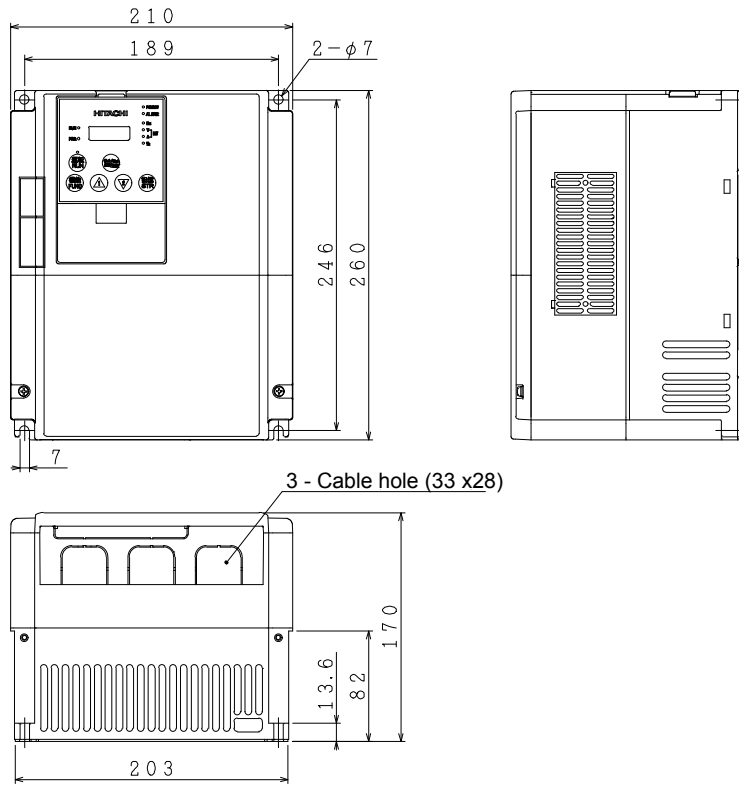

L700-185 to 300 LFF / HFF

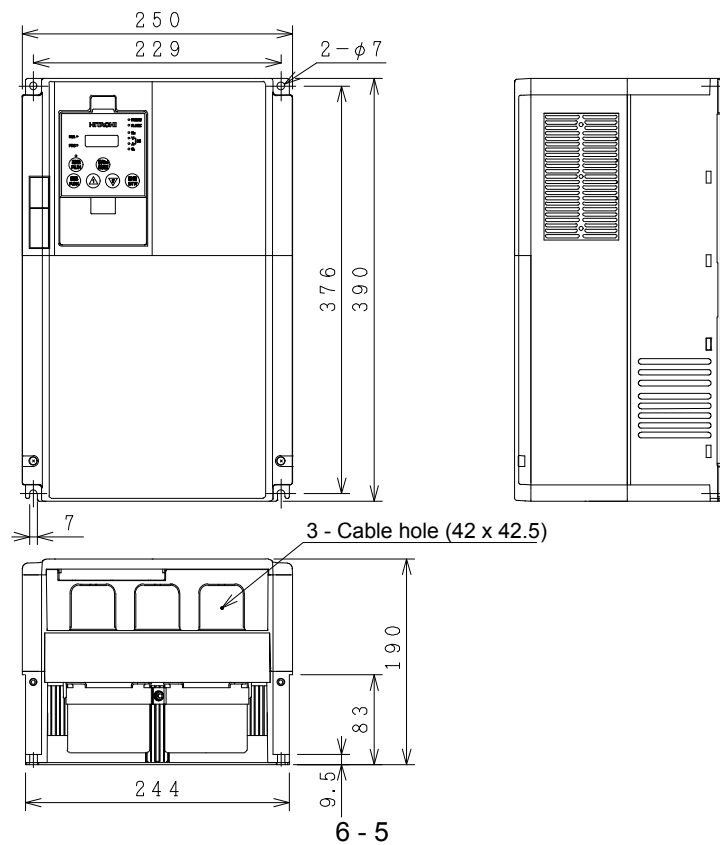

Chapter 6 Specifications

L700-300 LFF / HFF

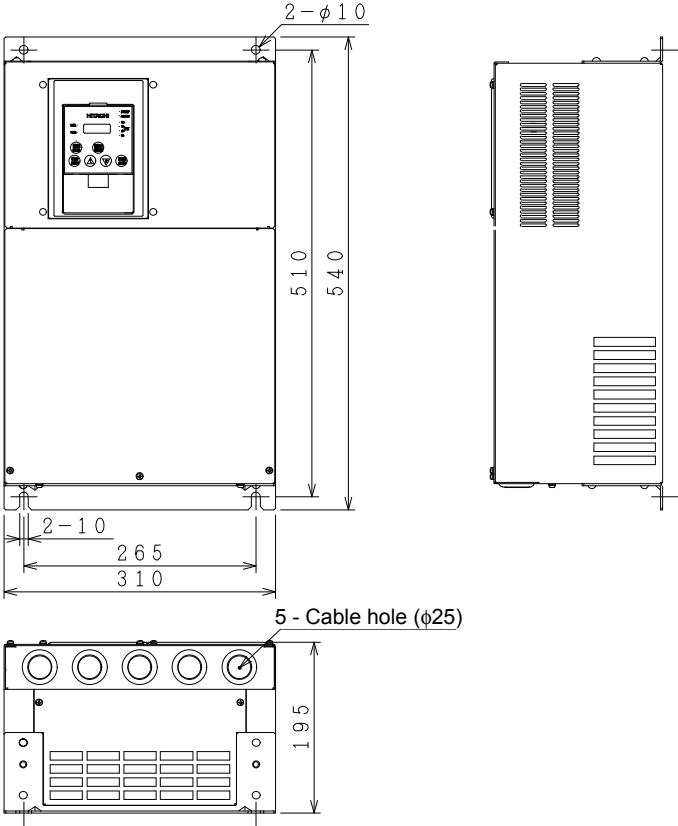

L700-450-550 LFF / HFF, 750 HFF

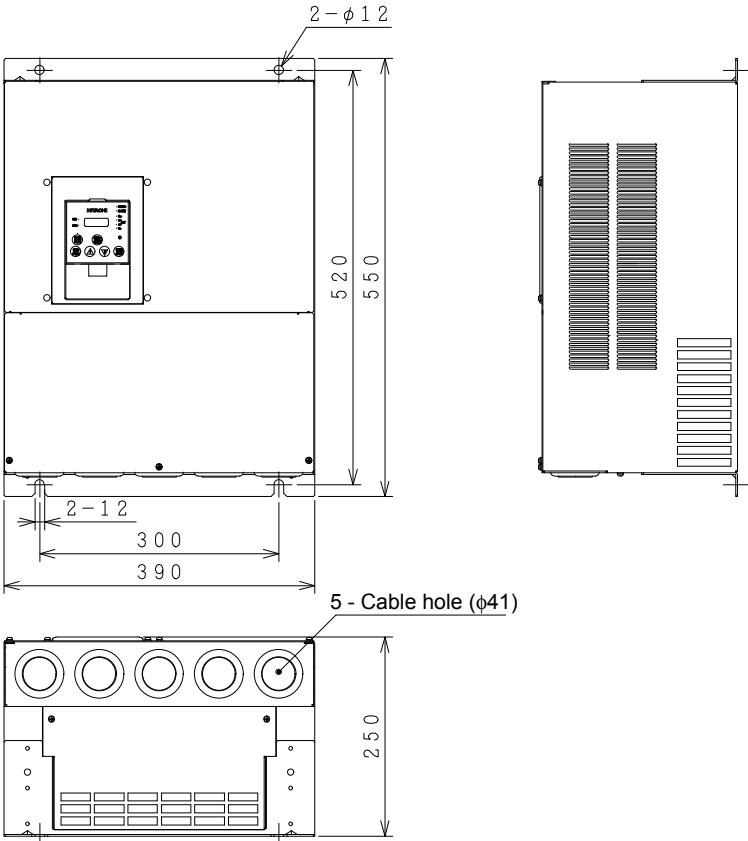

L700-750 LFF

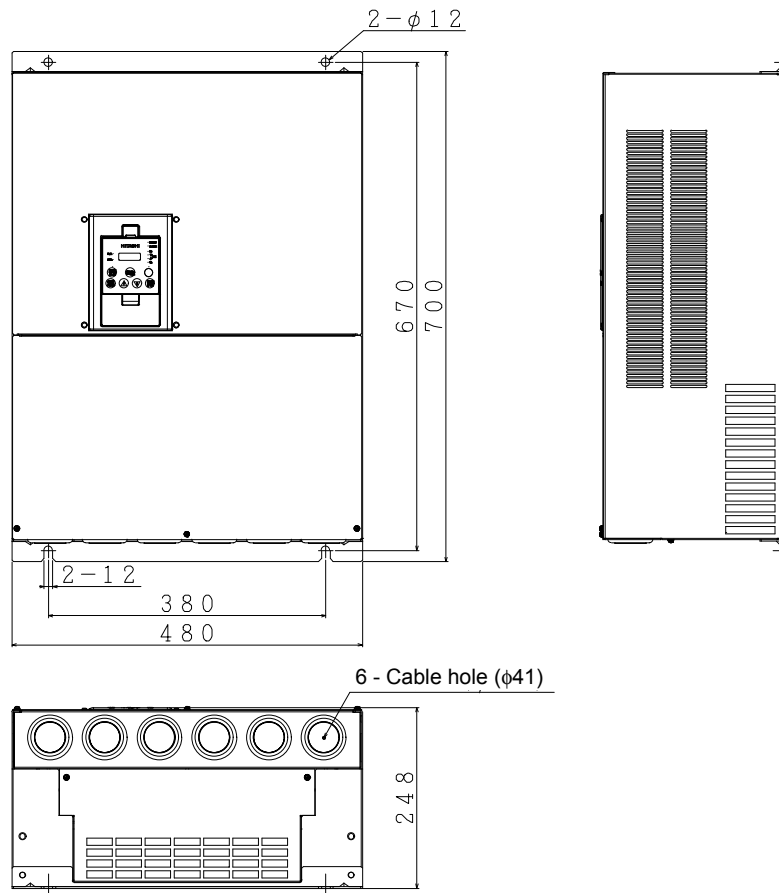

Chapter 6 Specifications

L700-900 to 1100HFF

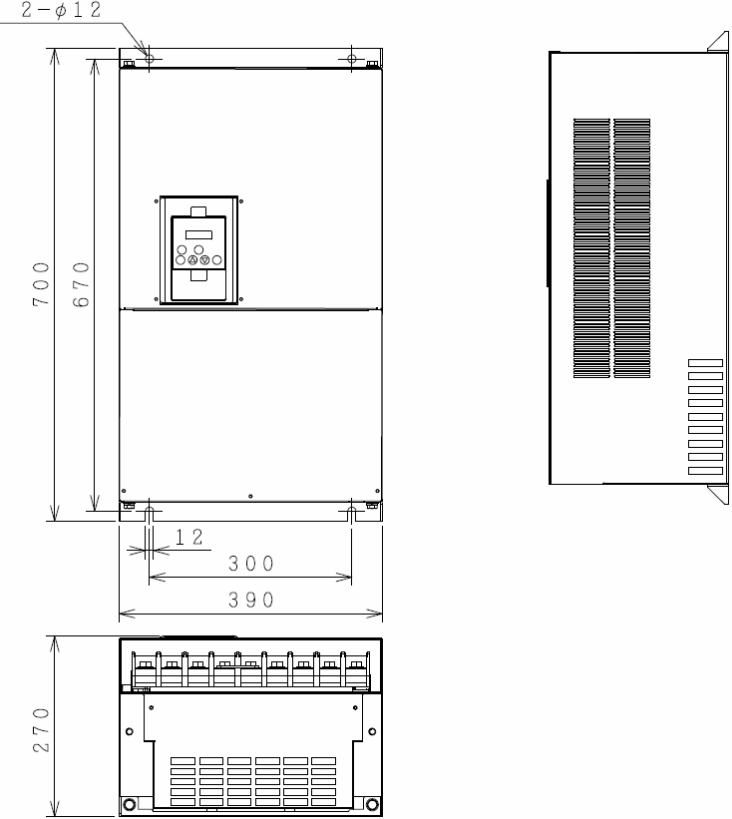

L700-1320 to 1600HFF

